

On-Board Type (DC) EMI Suppression Filters (EMIFIL®)



Chip Ferrite Beads BLM03/BLM15/BLM18/BLM21/BLM31/BLM41 Series

■ Features (BLM_A Series)

The chip ferrite beads BLM series comprises ferrite bead in the shape of a chip. This ferrite bead generates a high impedance which at high frequency mainly consists of a resistance element. The BLM series is effective in circuits without stable ground lines because the BLM series does not need a connection to ground.

The nickel barrier structure of the external electrodes provides excellent solder heat resistance.

BLM_A series generates an impedance from the relatively low frequencies. Therefore BLM_A series is effective in noise suppression in a wide frequency range (30MHz-several hundred MHz).

The small size of BLM03 series (0.6x0.3mm) is suitable for noise suppression of the small equipment such as PA modules for cellular phones.

■ Equivalent Circuit

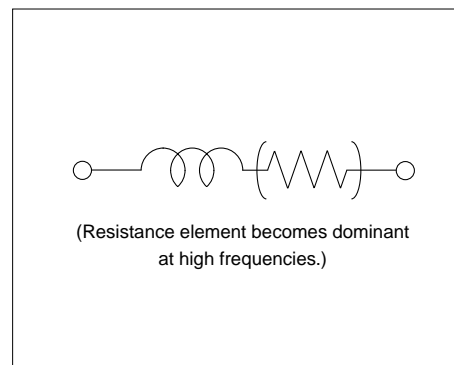

BLM03A Series (0201 Size)

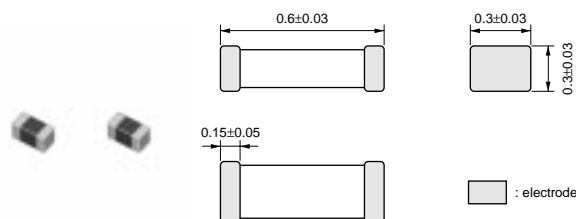

(in mm)

Part Number	Impedance (at 100MHz, 20 degree C) (ohm)	Rated Current (mA)	DC Resistance (max.) (ohm)	Operating Temperature Range (°C)
BLM03AG100SN1	10 (Typ.)	500	0.1	-55 to +125
BLM03AG700SN1	70 (Typ.)	200	0.5	-55 to +125
BLM03AG121SN1	120 ±25%	200	0.8	-55 to +125
BLM03AG241SN1	240 ±25%	100	1.0	-55 to +125

■ Impedance-Frequency (Typical)

BLM03 Series

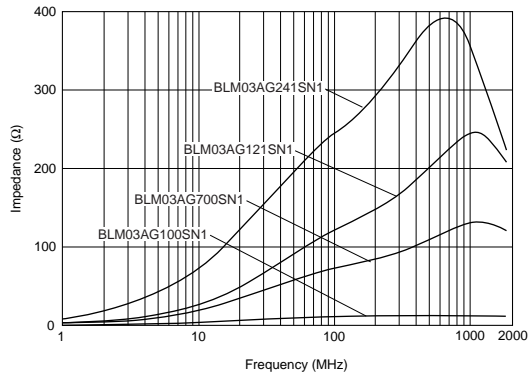

■ Impedance-Frequency Characteristics

BLM03AG100SN1

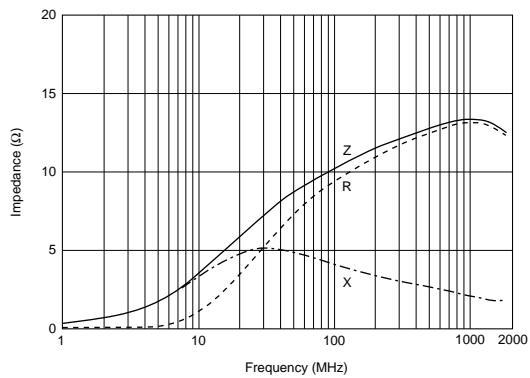

BLM03AG700SN1

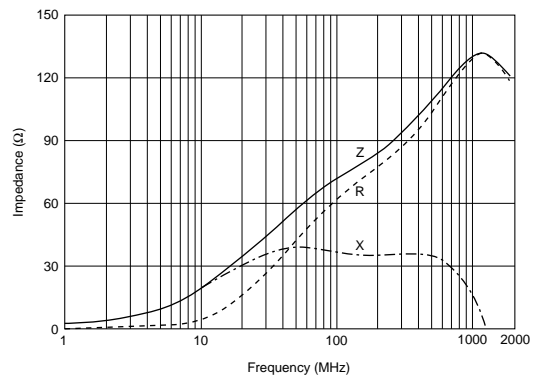

BLM03AG121SN1

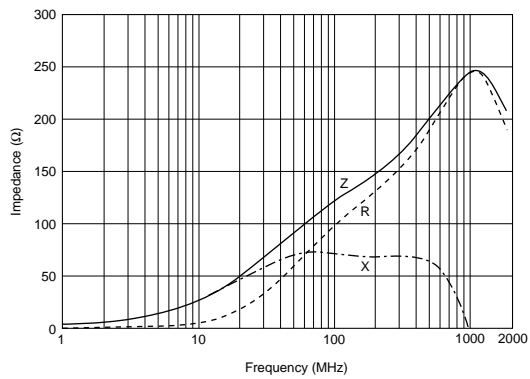

BLM03AG241SN1

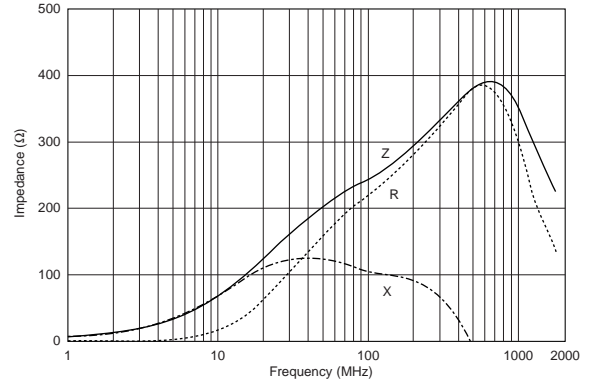

BLM15A Series (0402 Size)

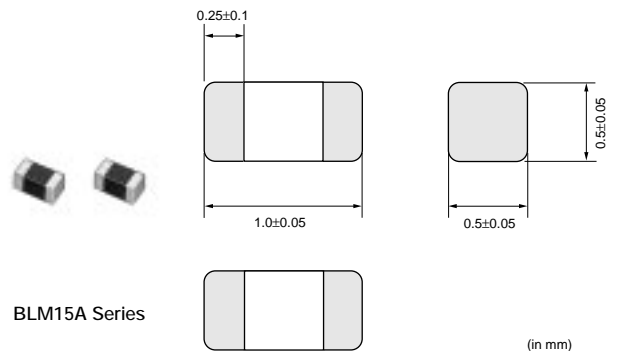

Part Number	Impedance (at 100MHz, 20 degree C) (ohm)	Rated Current (mA)	DC Resistance (max.) (ohm)	Operating Temperature Range (°C)
BLM15AG100SN1	10 (Typ.)	1000	0.05	-55 to +125
BLM15AG700SN1	70 (Typ.)	500	0.15	-55 to +125
BLM15AG121SN1	120 ±25%	500	0.25	-55 to +125
BLM15AG221SN1	220 ±25%	300	0.35	-55 to +125
BLM15AG601SN1	600 ±25%	300	0.6	-55 to +125
BLM15AG102SN1	1000 ±25%	200	1.0	-55 to +125

■ Impedance-Frequency (Typical)

BLM15A Series

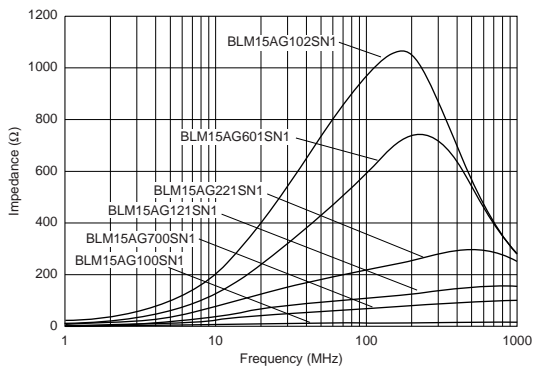

■ Impedance-Frequency Characteristics

BLM15AG100SN1

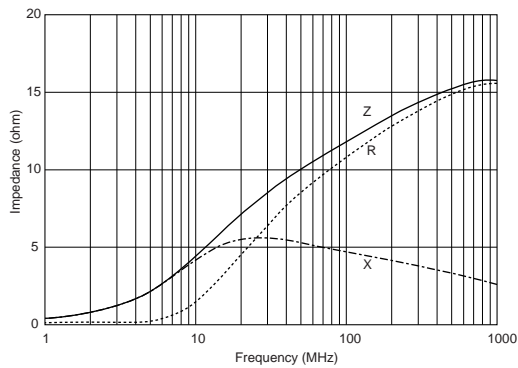

BLM15AG700SN1

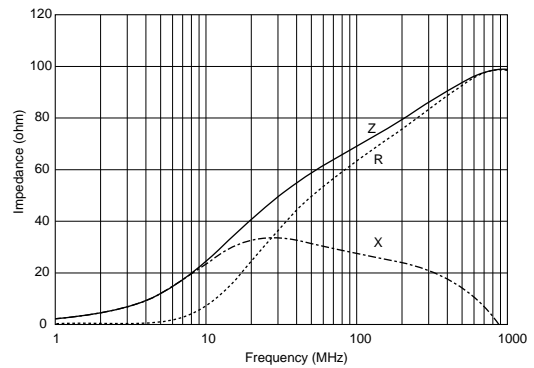

BLM15AG121SN1

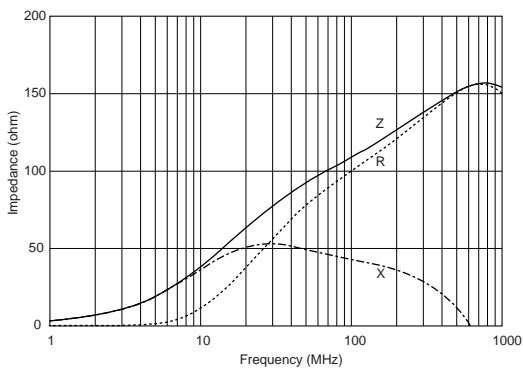

BLM15AG221SN1

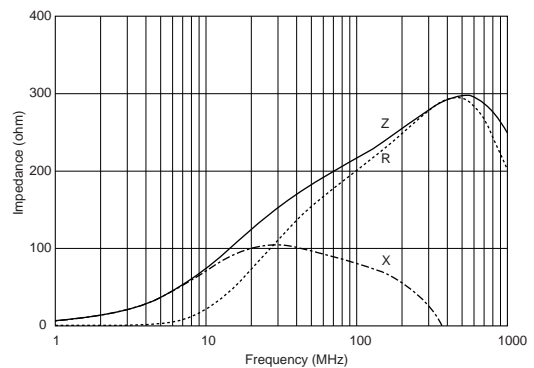

Continued on the following page. ↗

Continued from the preceding page.

Impedance-Frequency Characteristics

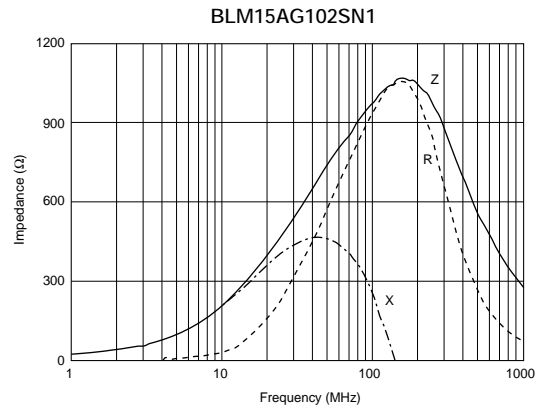
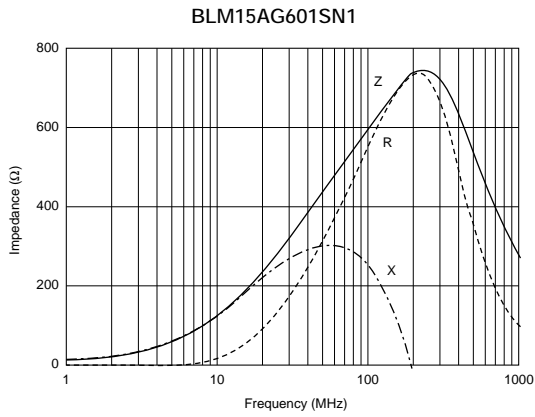

BLM18A Series (0603 Size)

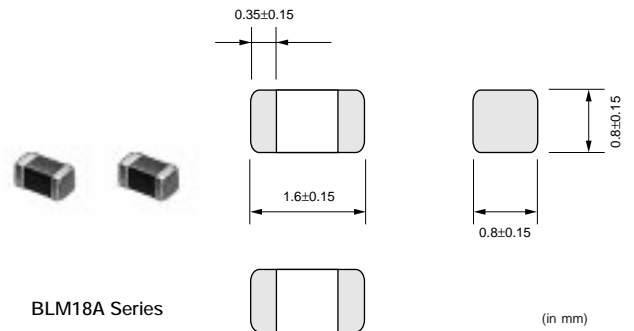

Part Number	Impedance (at 100MHz, 20 degree C) (ohm)	Rated Current (mA)	DC Resistance (max.) (ohm)	Operating Temperature Range (°C)
BLM18AG121SN1	120 ±25%	200	0.20	-55 to +125
BLM18AG151SN1	150 ±25%	200	0.25	-55 to +125
BLM18AG221SN1	220 ±25%	200	0.30	-55 to +125
BLM18AG331SN1	330 ±25%	200	0.45	-55 to +125
BLM18AG471SN1	470 ±25%	200	0.50	-55 to +125
BLM18AG601SN1	600 ±25%	200	0.50	-55 to +125
BLM18AG102SN1	1000 ±25%	100	0.70	-55 to +125

Impedance-Frequency (Typical)

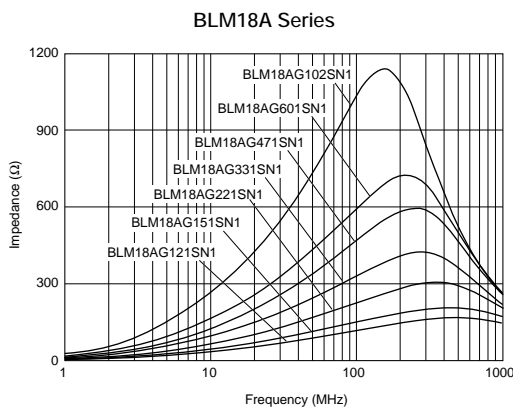

■ Impedance-Frequency Characteristics

BLM18AG121SN1

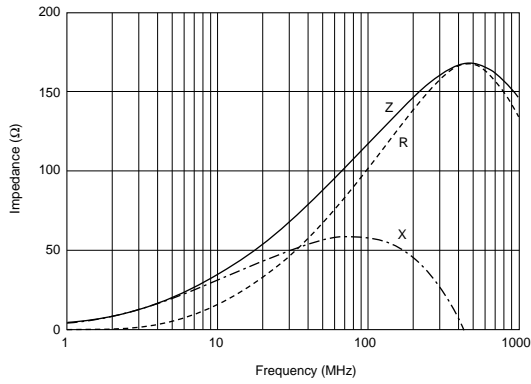

BLM18AG151SN1

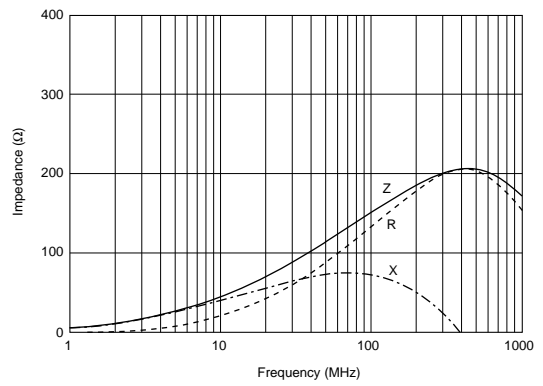

BLM18AG221SN1

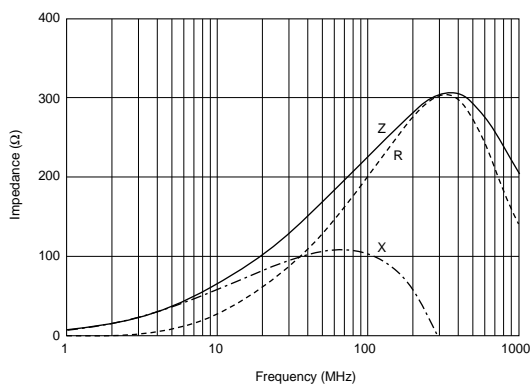

BLM18AG331SN1

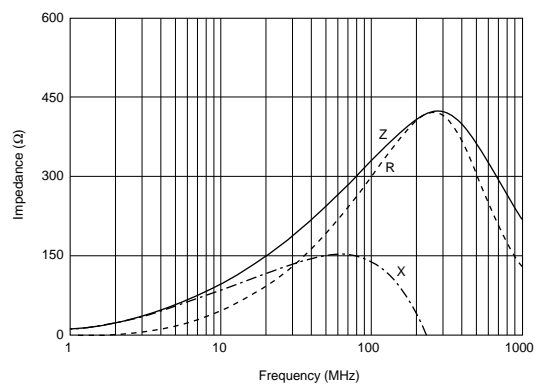

BLM18AG471SN1

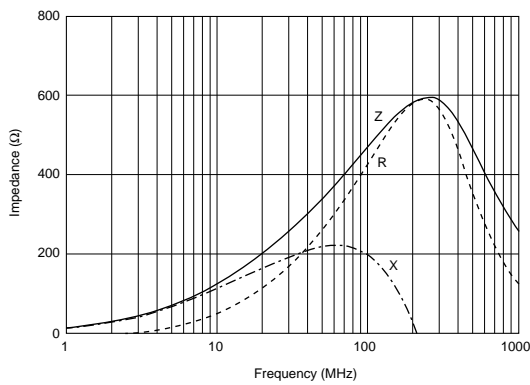

BLM18AG601SN1

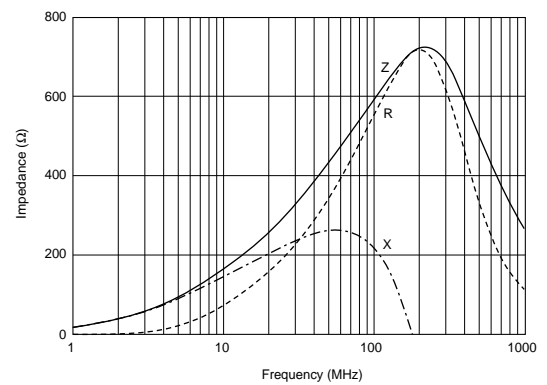

BLM18AG102SN1

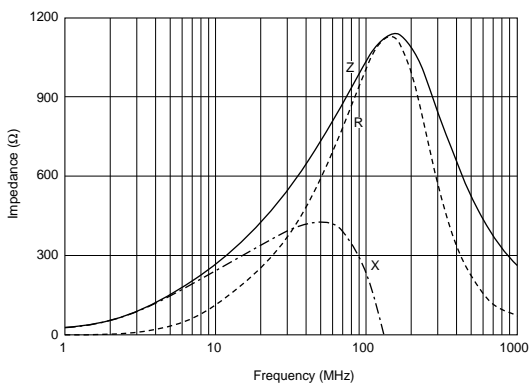

BLM21A Series (0805 Size)

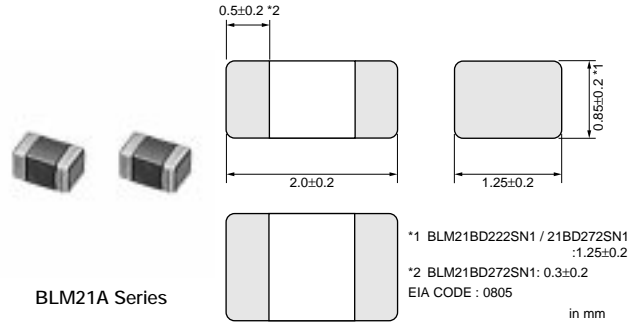

Part Number	Impedance (at 100MHz, 20 degree C) (ohm)	Rated Current (mA)	DC Resistance (max.) (ohm)	Operating Temperature Range (°C)
BLM21AG121SN1	120 ±25%	200	0.15	-55 to +125
BLM21AG151SN1	150 ±25%	200	0.15	-55 to +125
BLM21AG221SN1	220 ±25%	200	0.20	-55 to +125
BLM21AG331SN1	330 ±25%	200	0.25	-55 to +125
BLM21AG471SN1	470 ±25%	200	0.25	-55 to +125
BLM21AG601SN1	600 ±25%	200	0.30	-55 to +125
BLM21AG102SN1	1000 ±25%	200	0.45	-55 to +125

■ Impedance-Frequency (Typical)

BLM21A Series

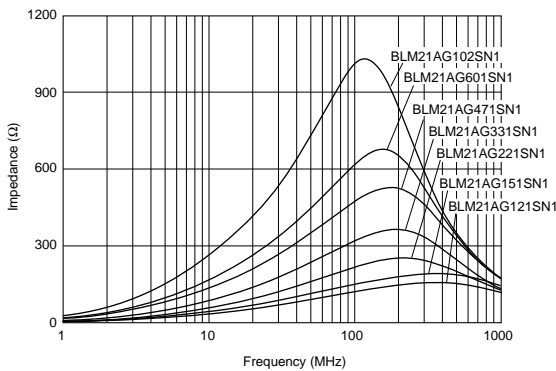

■ Impedance-Frequency Characteristics

BLM21AG121SN1

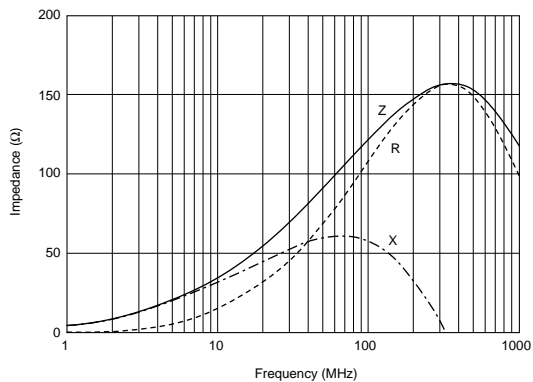

BLM21AG151SN1

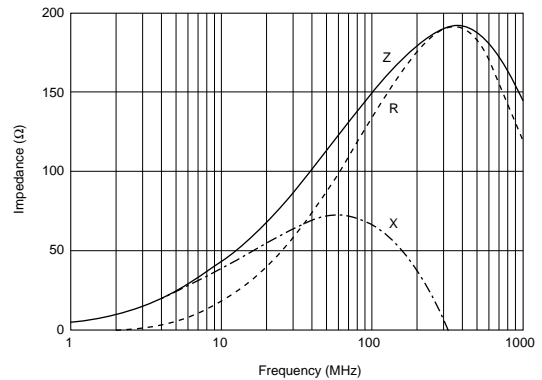

Continued on the following page. ↗

↳ Continued from the preceding page.

■ Impedance-Frequency Characteristics

BLM21AG221SN1

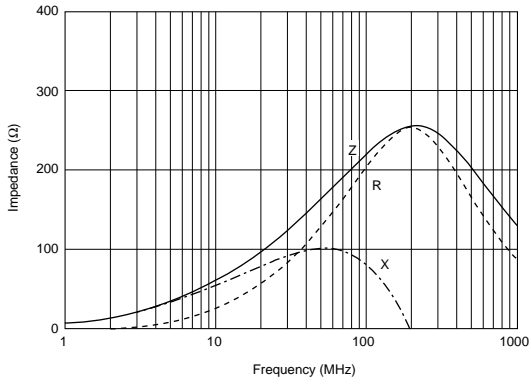

BLM21AG331SN1

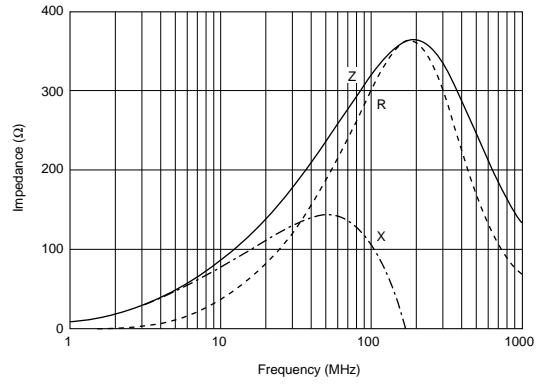

BLM21AG471SN1

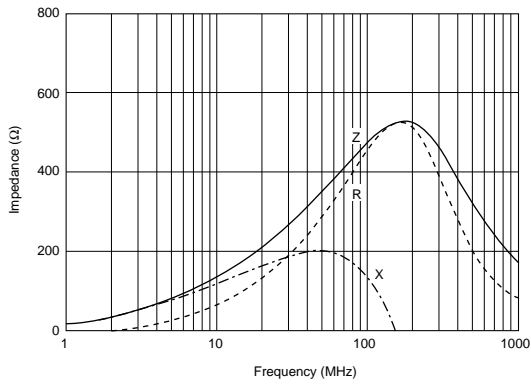

BLM21AG601SN1

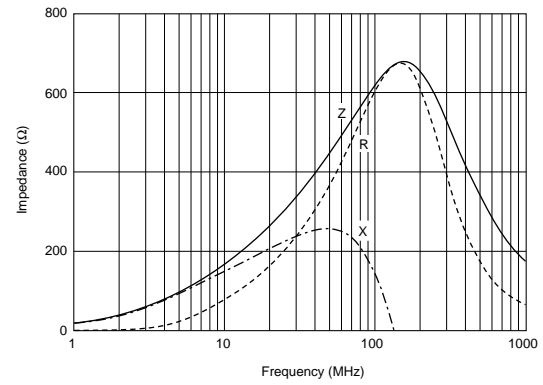

BLM21AG102SN1

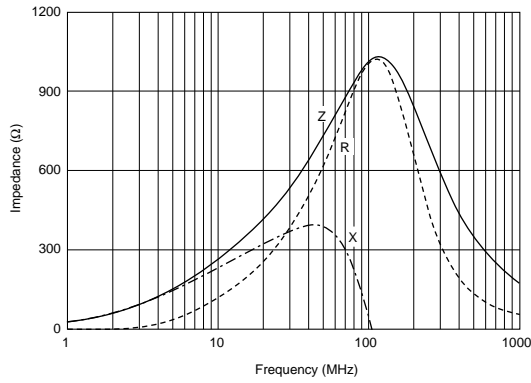

1

BLM31A Series (1206 Size)

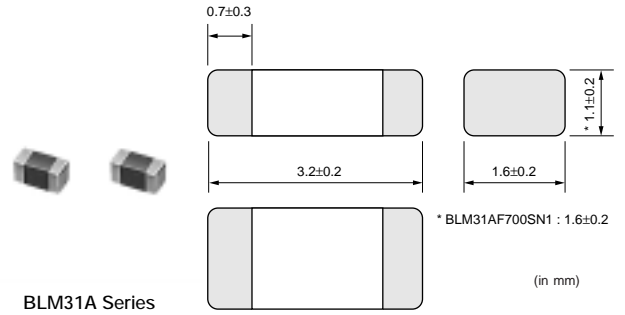

Part Number	Impedance (at 100MHz, 20 degree C) (ohm)	Rated Current (mA)	DC Resistance (max.) (ohm)	Operating Temperature Range (°C)
BLM31AJ260SN1	26 ±25%	500	0.05	-55 to +125
BLM31AF700SN1	70 ±25%	200	0.15	-55 to +125
BLM31AJ601SN1	600 ±25%	200	0.90	-55 to +125

■ Impedance-Frequency (Typical)

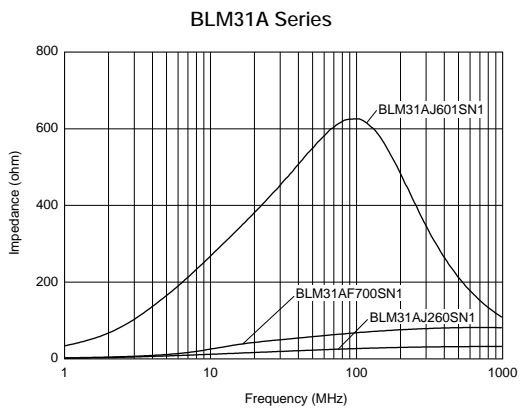

■ Impedance-Frequency Characteristics

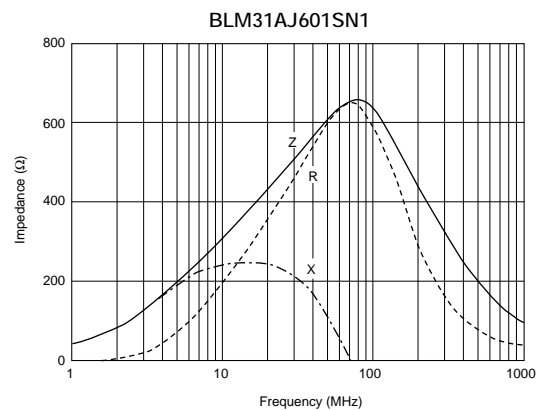
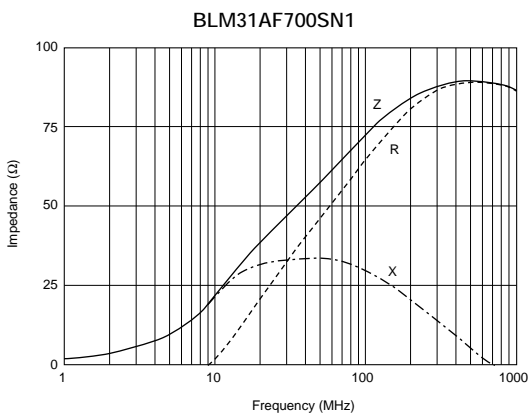
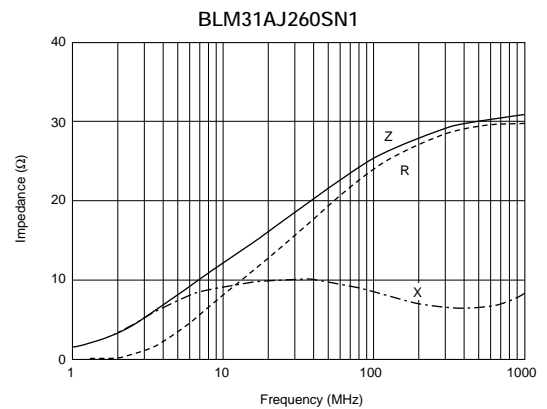

BLM41A Series (1806 Size)

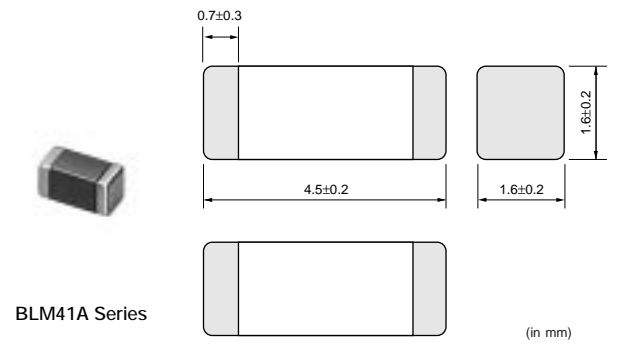

1

Part Number	Impedance (at 100MHz, 20 degree C) (ohm)	Rated Current (mA)	DC Resistance (max.) (ohm)	Operating Temperature Range (°C)
BLM41AF800SN1	80 ±25%	500	0.10	-55 to +125
BLM41AF151SN1	150 ±25%	200	0.50	-55 to +125

■ Impedance-Frequency (Typical)

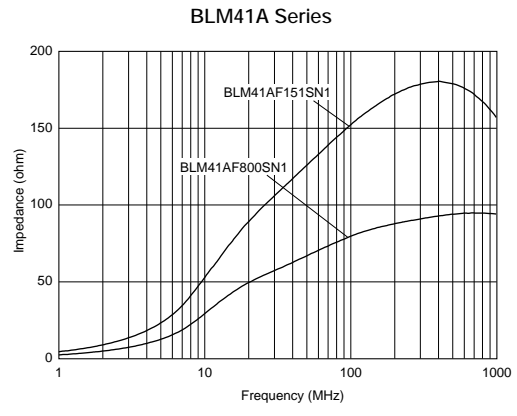

■ Impedance-Frequency Characteristics

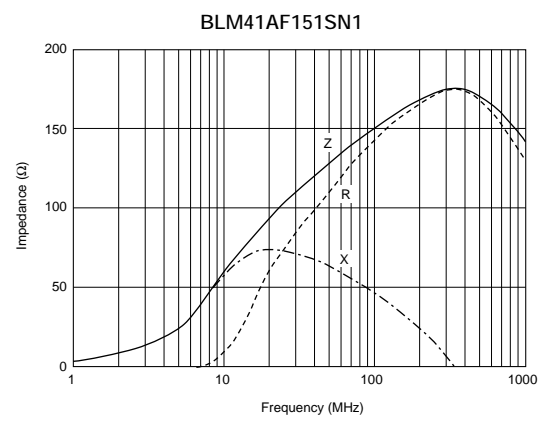
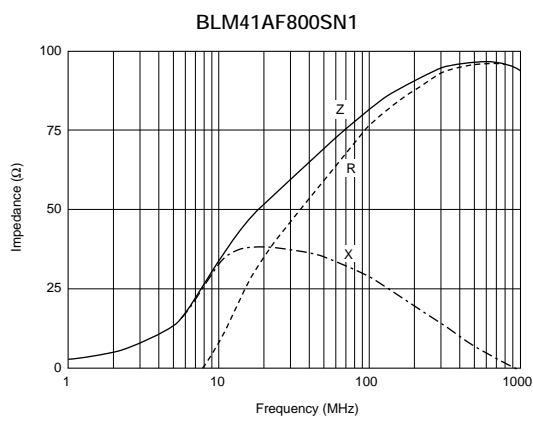

■ Features (BLM_B Series)

The chip ferrite beads BLM series comprises ferrite bead in the shape of a chip. This ferrite bead generates a high impedance which at high frequencies mainly consists of a resistance element. The BLM series is effective in circuits without stable ground lines because the BLM series does not need a connection to ground.

The nickel barrier structure of the external electrodes provides excellent solder heat resistance.

The BLM_B series can minimize attenuation of the signal waveform due to its sharp impedance characteristics. Various impedances are available to match signal frequency.

■ Equivalent Circuit

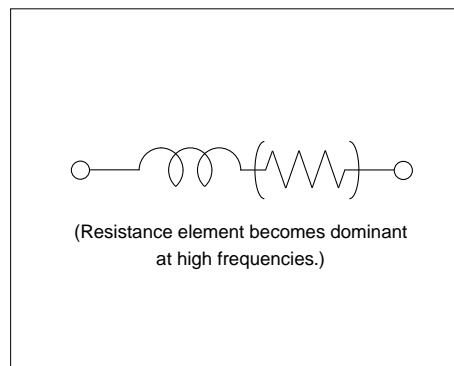

BLM15B Series (0402 Size)

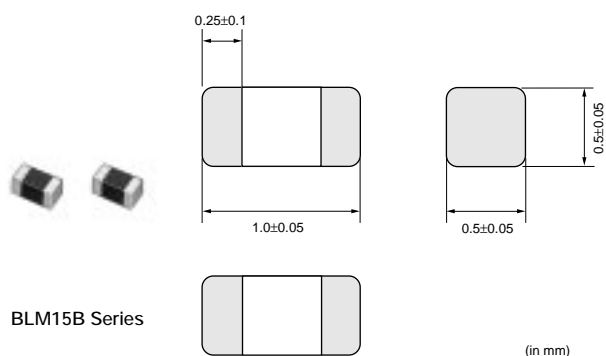

Part Number	Impedance (at 100MHz, 20 degree C) (ohm)	Rated Current (mA)	DC Resistance (max.) (ohm)	Operating Temperature Range (°C)
BLM15BB050SN1	5 ±25%	500	0.08	-55 to +125
BLM15BB100SN1	10 ±25%	300	0.10	-55 to +125
BLM15BB220SN1	22 ±25%	300	0.20	-55 to +125
BLM15BB470SN1	47 ±25%	300	0.35	-55 to +125
BLM15BB750SN1	75 ±25%	300	0.40	-55 to +125
BLM15BB121SN1	120 ±25%	300	0.55	-55 to +125
BLM15BB221SN1	220 ±25%	200	0.80	-55 to +125
BLM15BD471SN1	470 ±25%	200	0.60	-55 to +125
BLM15BD601SN1	600 ±25%	200	0.65	-55 to +125
BLM15BD102SN1	1000 ±25%	200	0.90	-55 to +125

■ Impedance-Frequency (Typical)

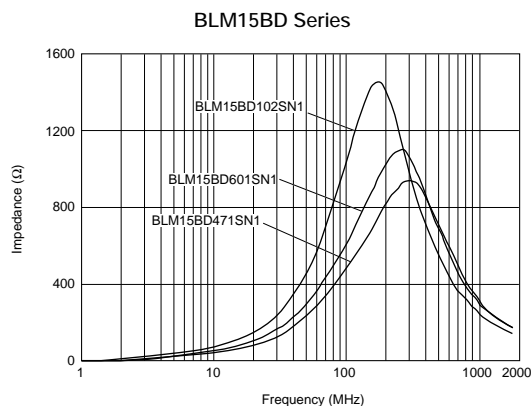
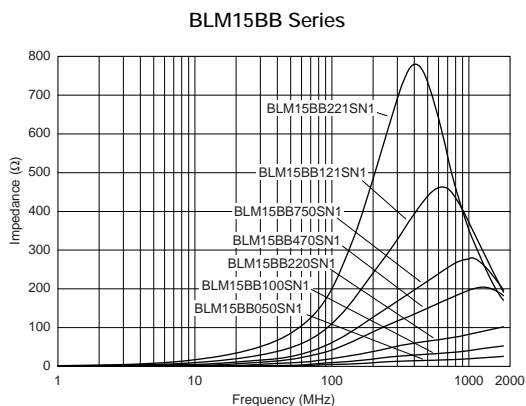

Continued on the following page. ↗

Continued from the preceding page.

Impedance-Frequency Characteristics

BLM15BB050SN1

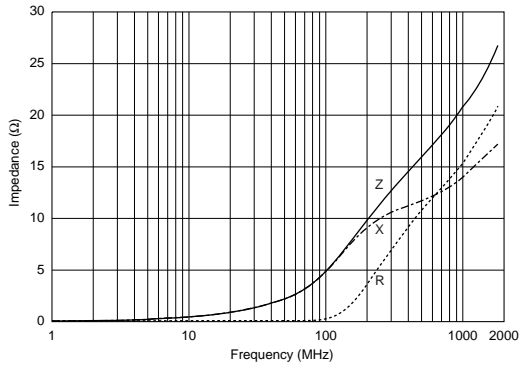

BLM15BB100SN1

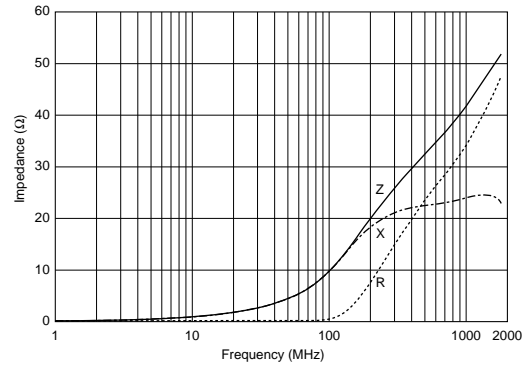

BLM15BB220SN1

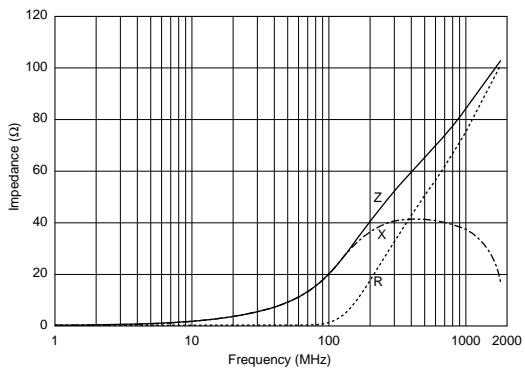

BLM15BB470SN1

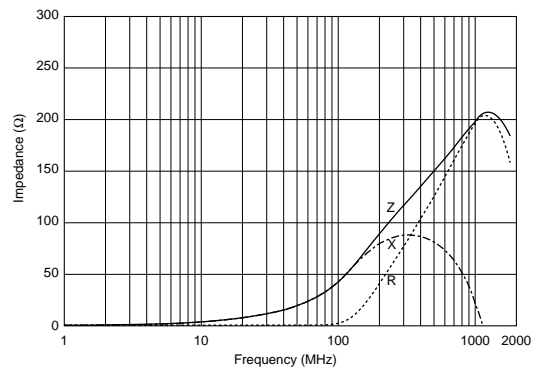

BLM15BB750SN1

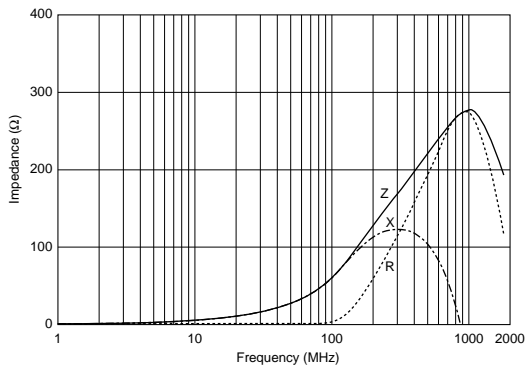

BLM15BB121SN1

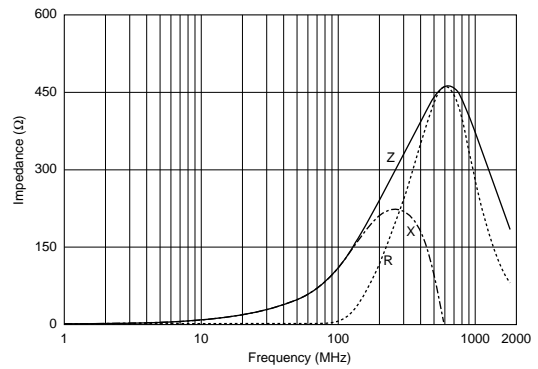

BLM15BB221SN1

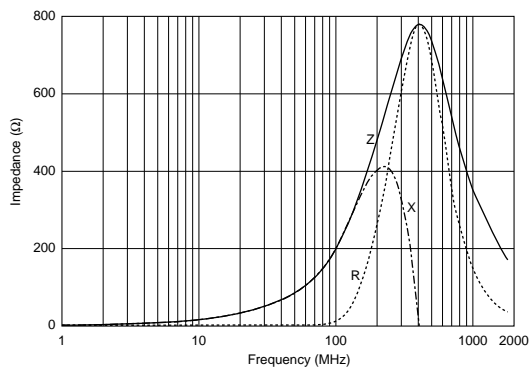

BLM15BD471SN1

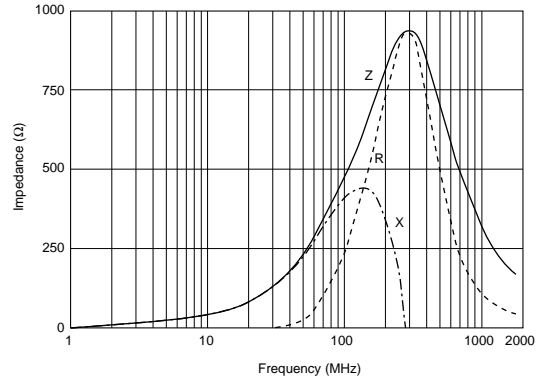

Continued on the following page. ↗

↳ Continued from the preceding page.

■ Impedance-Frequency Characteristics

BLM15BD601SN1

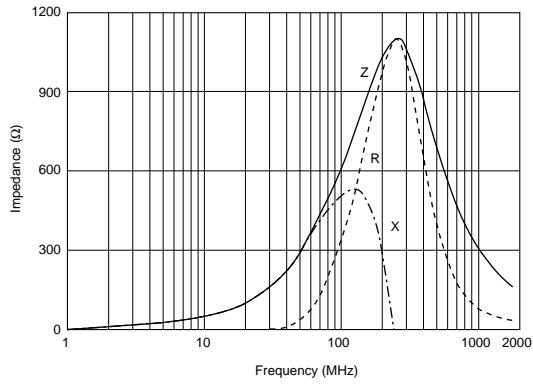

BLM15BD102SN1

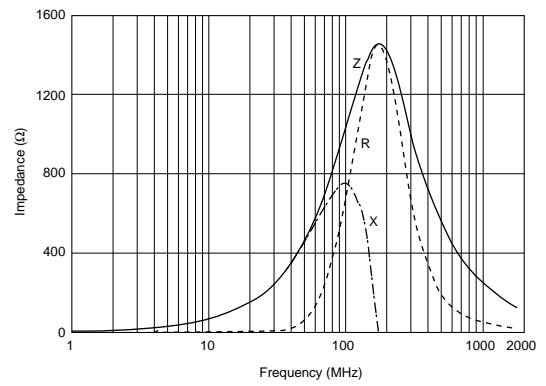

1

BLM18B Series (0603 Size)

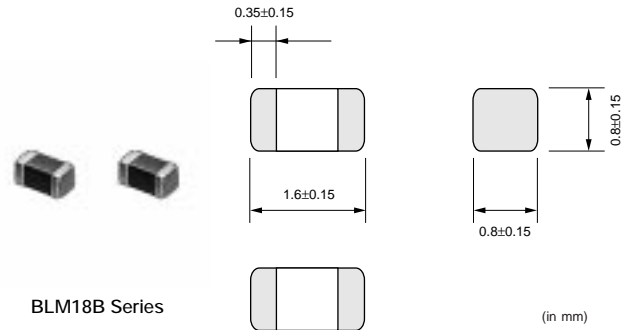

Part Number	Impedance (at 100MHz, 20 degree C) (ohm)	Rated Current (mA)	DC Resistance (max.) (ohm)	Operating Temperature Range (°C)
BLM18BA050SN1	5 ±25%	500	0.20	-55 to +125
BLM18BB050SN1	5 ±25%	700	0.10	-55 to +125
BLM18BA100SN1	10 ±25%	500	0.25	-55 to +125
BLM18BB100SN1	10 ±25%	500	0.15	-55 to +125
BLM18BA220SN1	22 ±25%	500	0.35	-55 to +125
BLM18BB220SN1	22 ±25%	500	0.25	-55 to +125
BLM18BA470SN1	47 ±25%	300	0.55	-55 to +125
BLM18BB470SN1	47 ±25%	500	0.30	-55 to +125
BLM18BB600SN1	60 ±25%	200	0.35	-55 to +125
BLM18BA750SN1	75 ±25%	300	0.70	-55 to +125
BLM18BB750SN1	75 ±25%	200	0.35	-55 to +125
BLM18BA121SN1	120 ±25%	200	0.90	-55 to +125
BLM18BB121SN1	120 ±25%	200	0.50	-55 to +125
BLM18BD121SN1	120 ±25%	200	0.40	-55 to +125
BLM18BB141SN1	140 ±25%	200	0.55	-55 to +125
BLM18BB151SN1	150 ±25%	200	0.55	-55 to +125
BLM18BD151SN1	150 ±25%	200	0.40	-55 to +125
BLM18BB221SN1	220 ±25%	200	0.65	-55 to +125
BLM18BD221SN1	220 ±25%	200	0.45	-55 to +125
BLM18BB331SN1	330 ±25%	200	0.75	-55 to +125
BLM18BD331SN1	330 ±25%	200	0.50	-55 to +125
BLM18BD421SN1	420 ±25%	200	0.55	-55 to +125
BLM18BB471SN1	470 ±25%	50	1.00	-55 to +125
BLM18BD471SN1	470 ±25%	200	0.55	-55 to +125
BLM18BD601SN1	600 ±25%	200	0.65	-55 to +125
BLM18BD102SN1	1000 ±25%	100	0.85	-55 to +125
BLM18BD152SN1	1500 ±25%	50	1.20	-55 to +125
BLM18BD182SN1	1800 ±25%	50	1.50	-55 to +125
BLM18BD222SN1	2200 ±25%	50	1.50	-55 to +125
BLM18BD252SN1	2500 ±25%	50	1.50	-55 to +125

■ Impedance-Frequency (Typical)

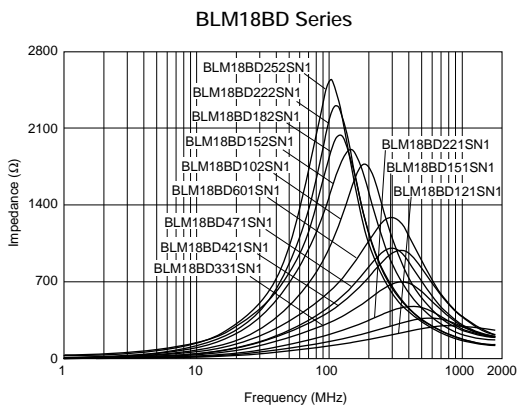
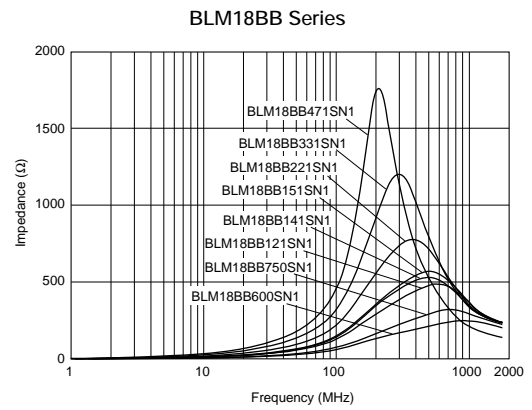
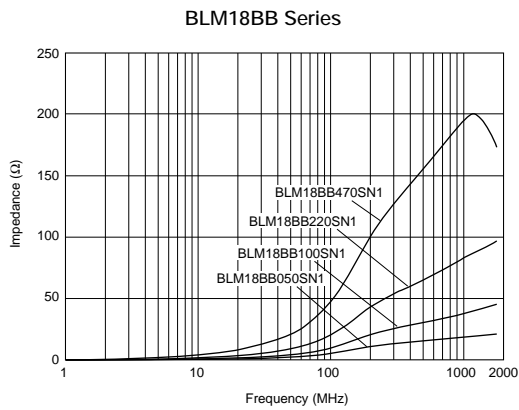
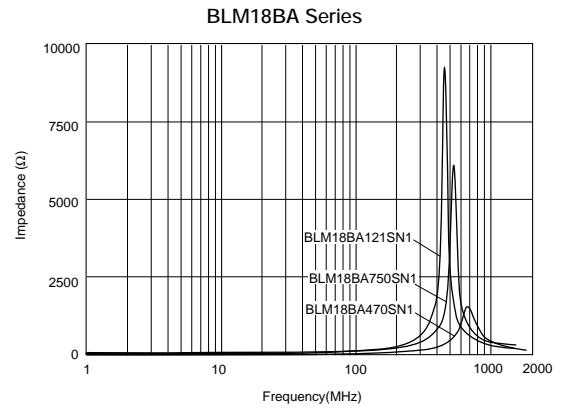
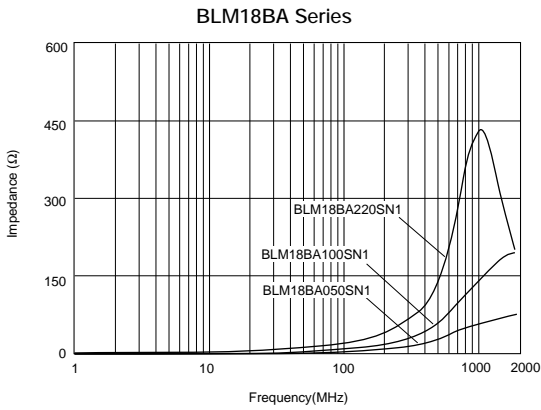

■ Impedance-Frequency Characteristics

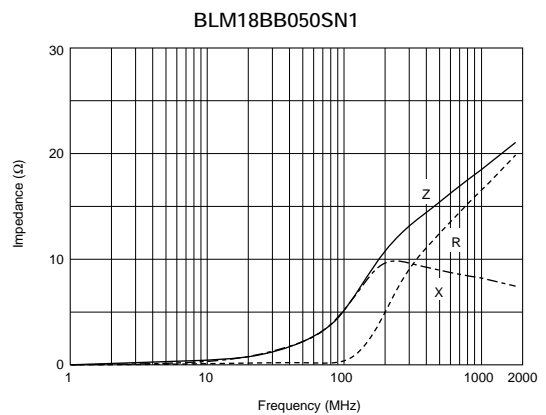
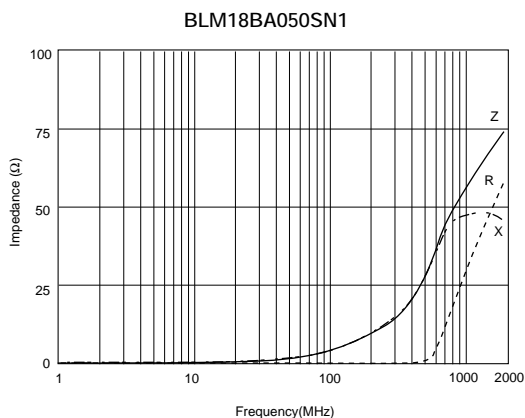

Continued on the following page. ↗

Continued from the preceding page.

Impedance-Frequency Characteristics

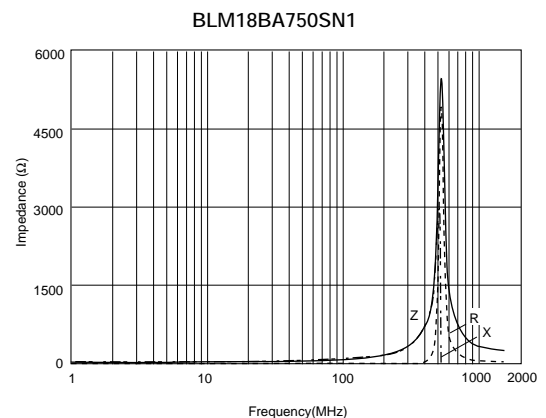
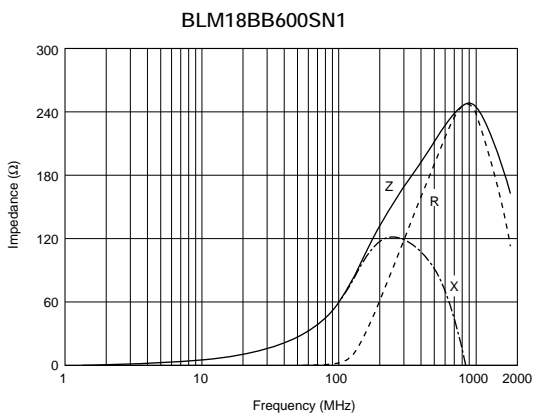
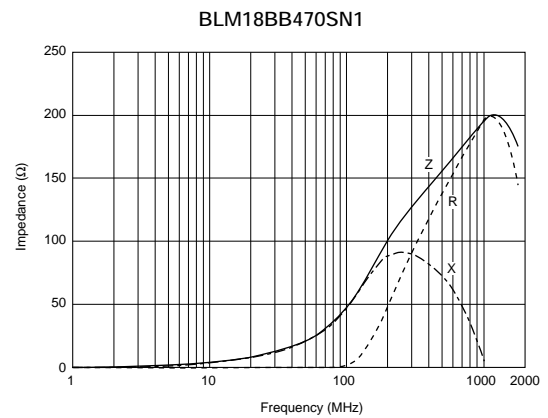
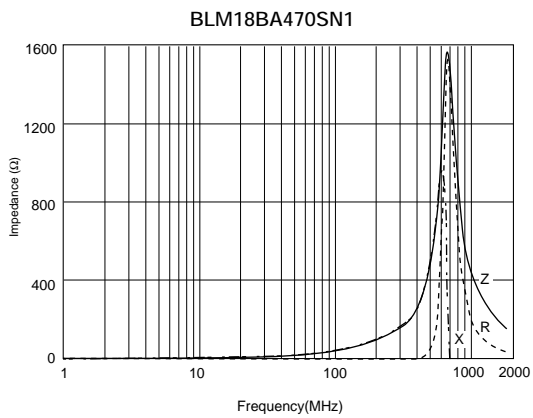
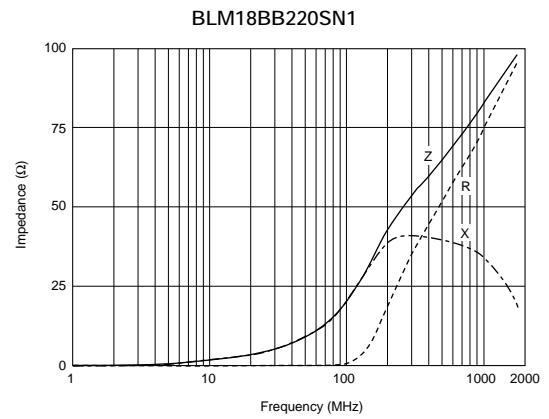
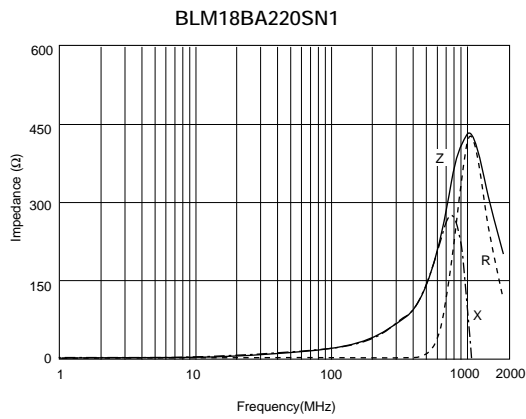
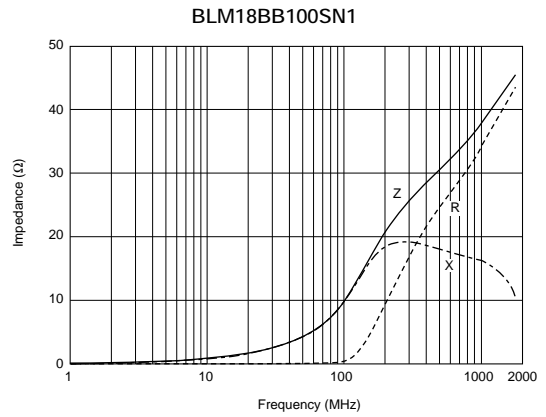
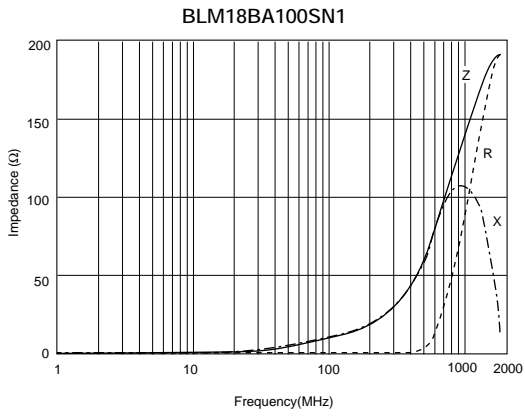

Continued on the following page. ↗

Continued from the preceding page.

Impedance-Frequency Characteristics

1

BLM18BB750SN1

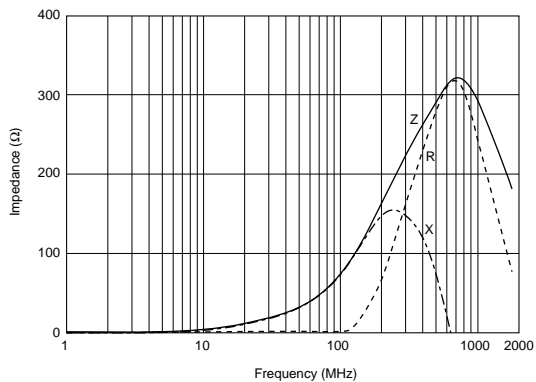

BLM18BA121SN1

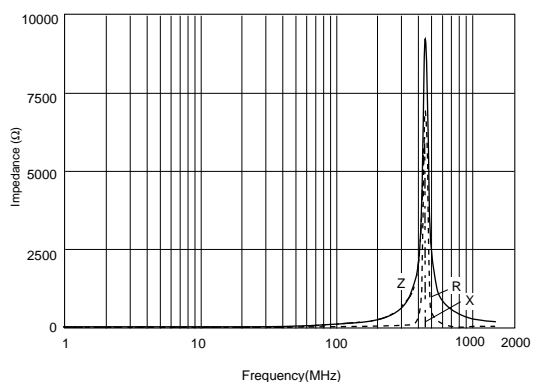

BLM18BB121SN1

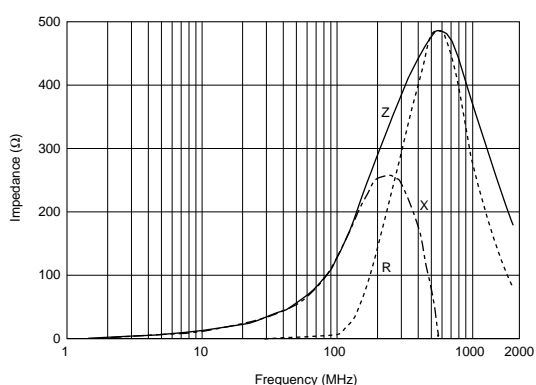

BLM18BD121SN1

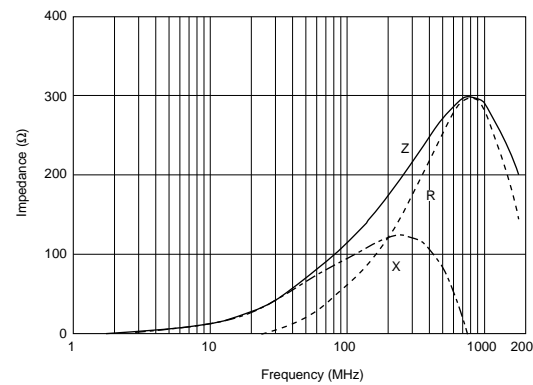

BLM18BB141SN1

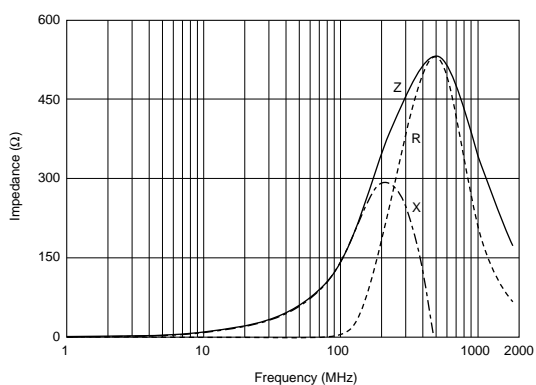

BLM18BB151SN1

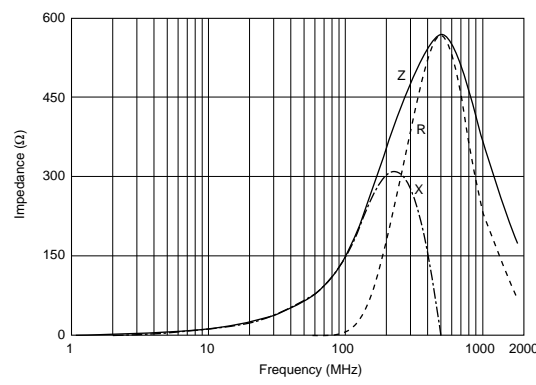

BLM18BD151SN1

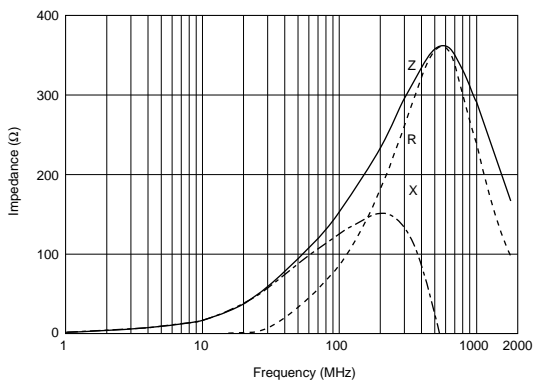

BLM18BB221SN1

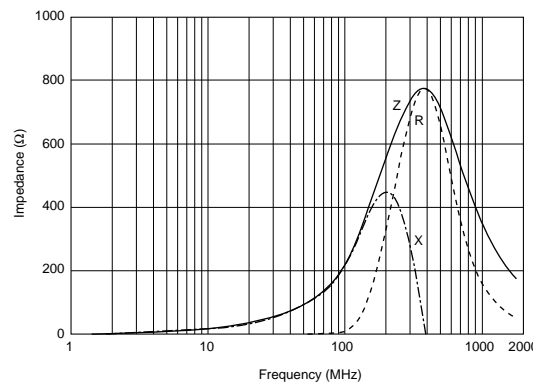

Continued on the following page. ↗

Continued from the preceding page.

Impedance-Frequency Characteristics

BLM18BD221SN1

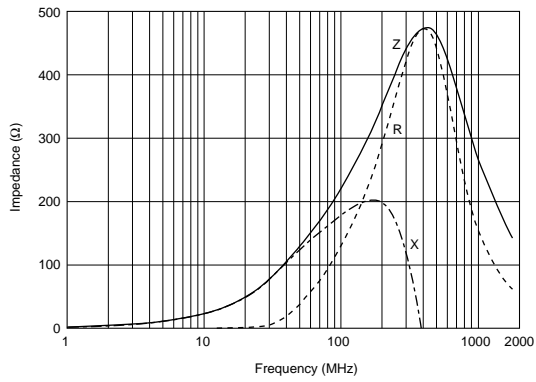

BLM18BB331SN1

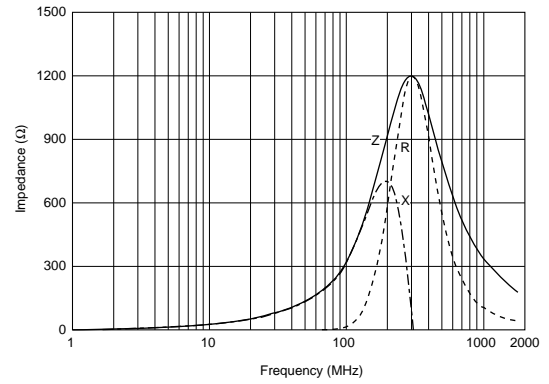

BLM18BD331SN1

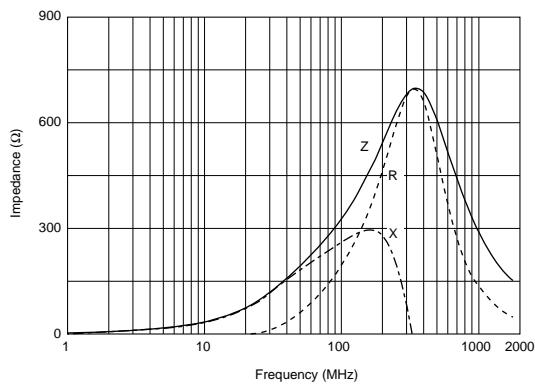

BLM18BD421SN1

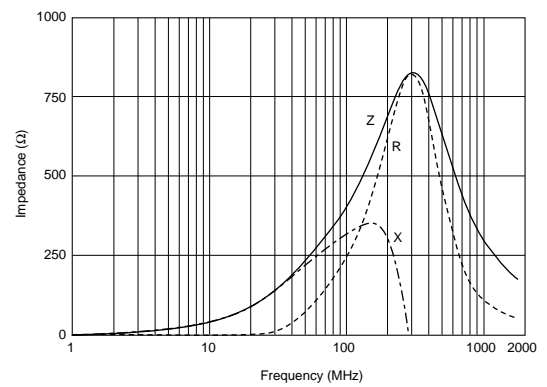

BLM18BB471SN1

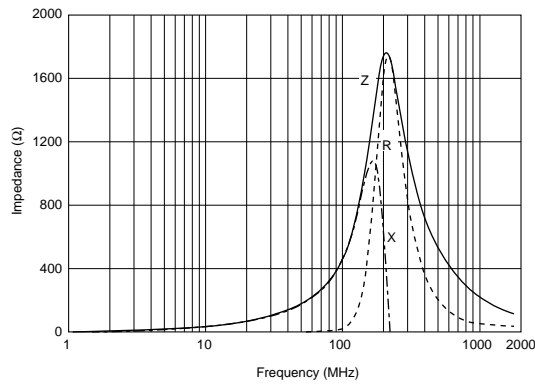

BLM18BD471SN1

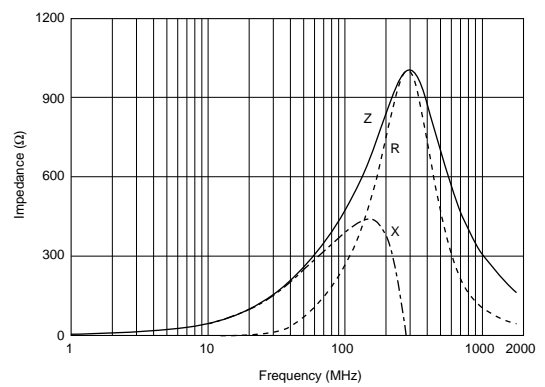

BLM18BD601SN1

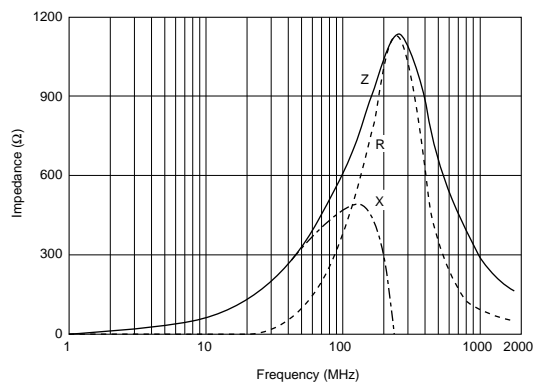

BLM18BD102SN1

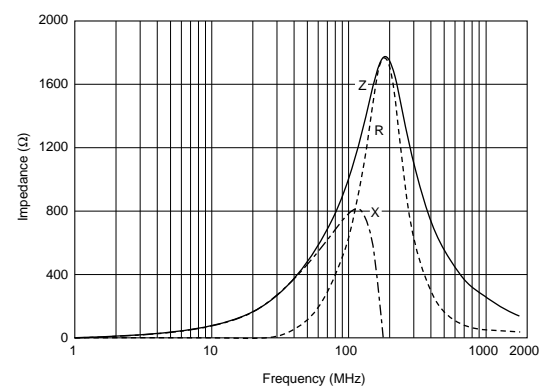

Continued on the following page. ↗

Continued from the preceding page.

Impedance-Frequency Characteristics

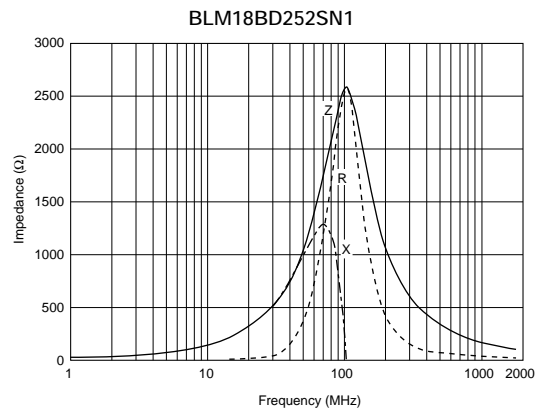
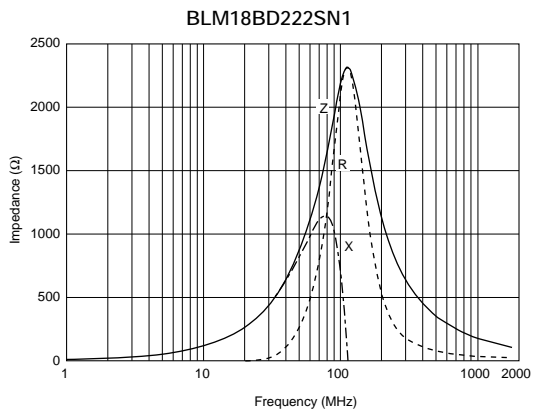
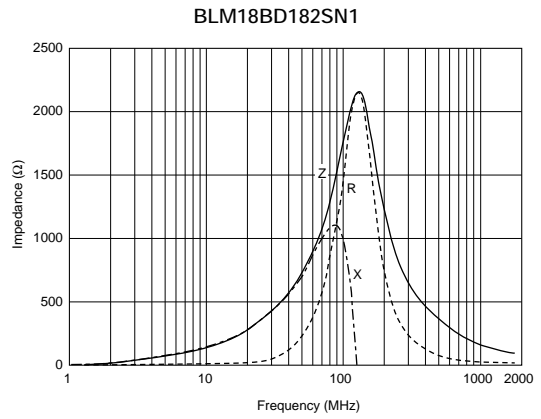
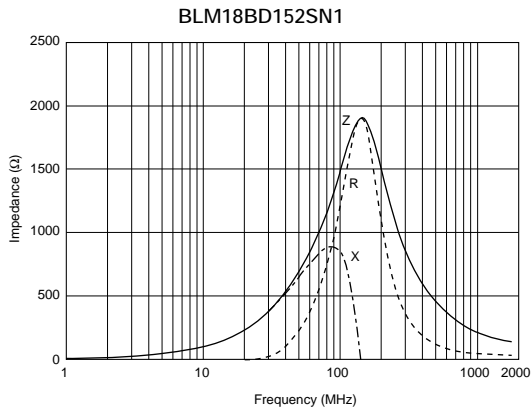

1

BLM21B Series (0805 Size)

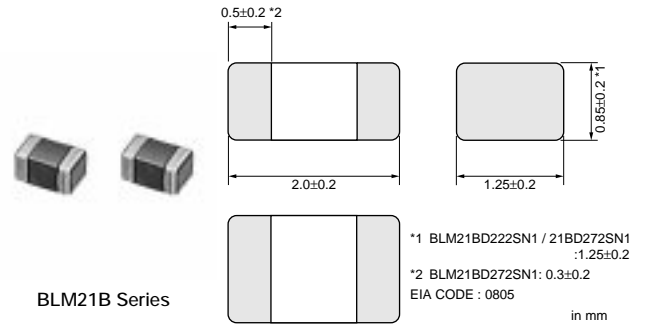

Part Number	Impedance (at 100MHz, 20 degree C) (ohm)	Rated Current (mA)	DC Resistance (max.) (ohm)	Operating Temperature Range (°C)
BLM21BB050SN1	5 ±25%	500	0.07	-55 to +125
BLM21BB600SN1	60 ±25%	200	0.20	-55 to +125
BLM21BB750SN1	75 ±25%	200	0.25	-55 to +125
BLM21BB121SN1	120 ±25%	200	0.25	-55 to +125
BLM21BD121SN1	120 ±25%	200	0.25	-55 to +125
BLM21BB151SN1	150 ±25%	200	0.25	-55 to +125
BLM21BD151SN1	150 ±25%	200	0.25	-55 to +125
BLM21BB201SN1	200 ±25%	200	0.35	-55 to +125
BLM21BB221SN1	220 ±25%	200	0.35	-55 to +125
BLM21BD221SN1	220 ±25%	200	0.25	-55 to +125
BLM21BB331SN1	330 ±25%	200	0.40	-55 to +125
BLM21BD331SN1	330 ±25%	200	0.30	-55 to +125
BLM21BD421SN1	420 ±25%	200	0.30	-55 to +125
BLM21BB471SN1	470 ±25%	200	0.45	-55 to +125
BLM21BD471SN1	470 ±25%	200	0.35	-55 to +125
BLM21BD601SN1	600 ±25%	200	0.35	-55 to +125
BLM21BD751SN1	750 ±25%	200	0.40	-55 to +125
BLM21BD102SN1	1000 ±25%	200	0.40	-55 to +125
BLM21BD152SN1	1500 ±25%	200	0.45	-55 to +125
BLM21BD182SN1	1800 ±25%	200	0.50	-55 to +125
BLM21BD222TN1	2200 ±25%	200	0.60	-55 to +125
BLM21BD222SN1	2250 (Typ.)	200	0.60	-55 to +125
BLM21BD272SN1	2700 ±25%	200	0.80	-55 to +125

■ Impedance-Frequency (Typical)

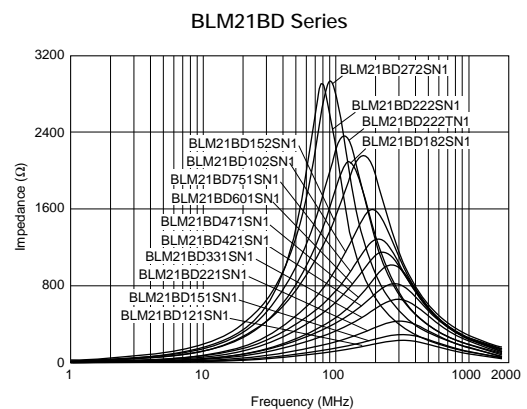
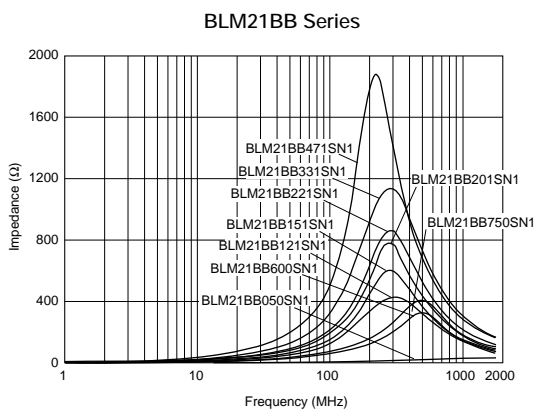

Continued on the following page. ↗

Continued from the preceding page.

Impedance-Frequency Characteristics

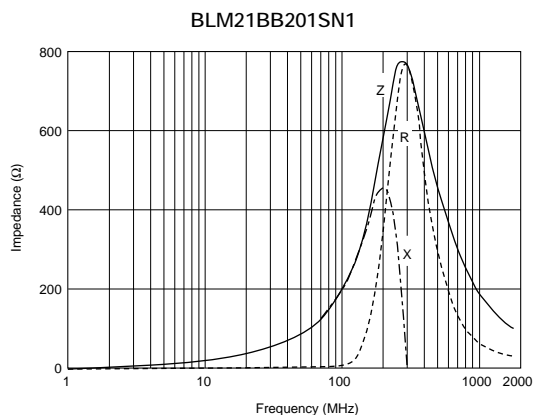
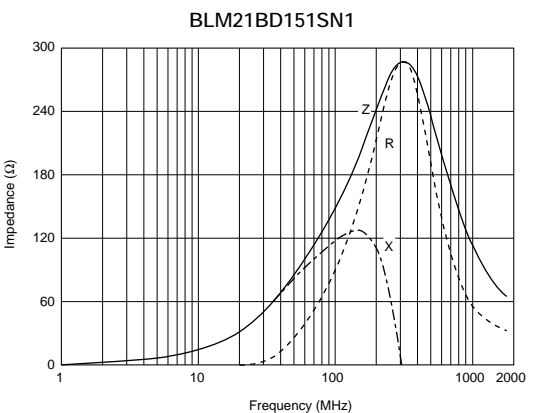
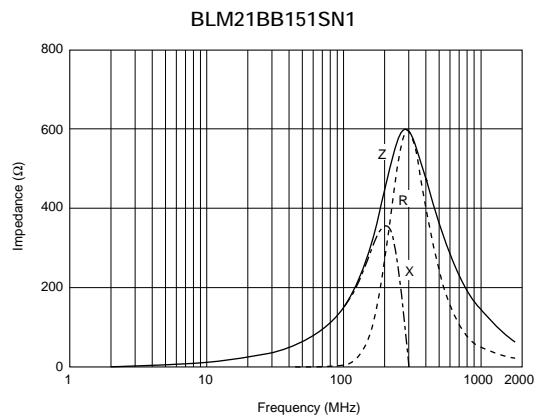
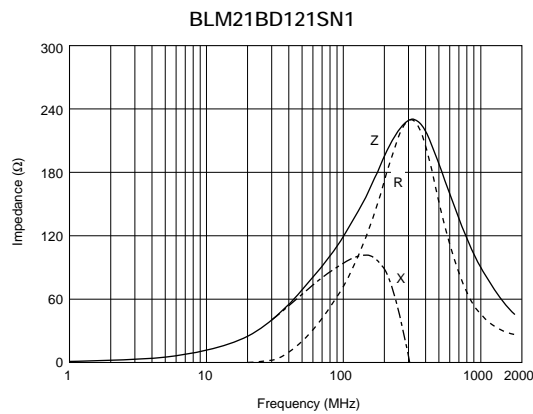
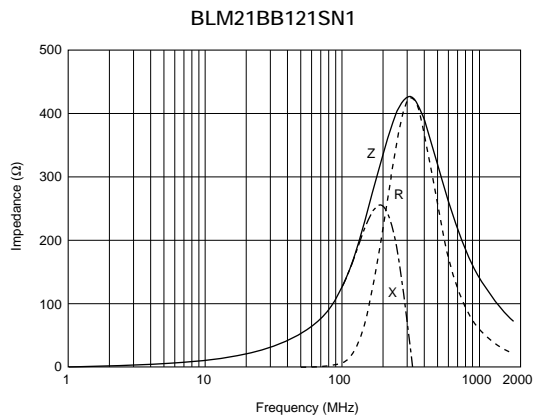
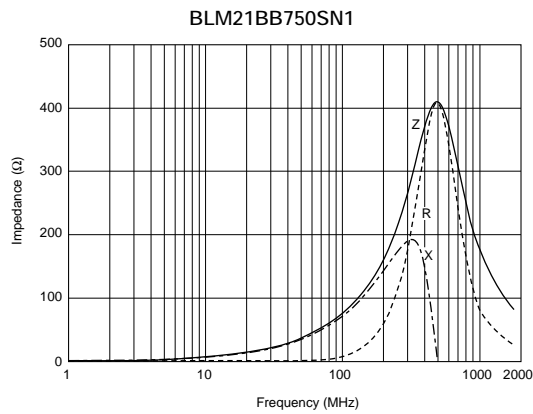
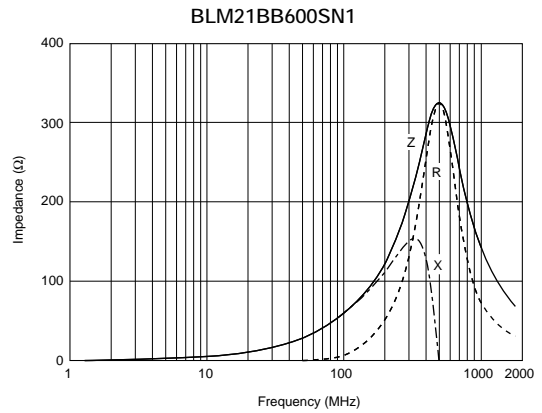
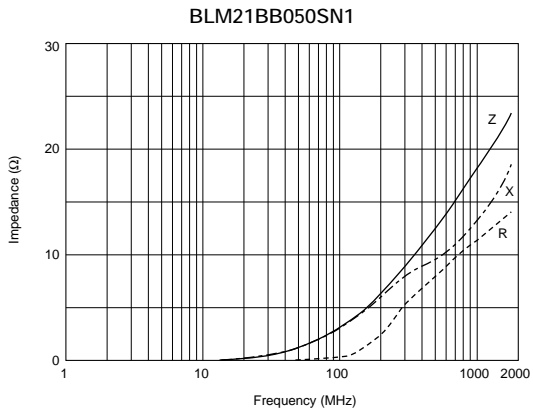

1

Continued from the preceding page.

■ Impedance-Frequency Characteristics

BLM21BB221SN1

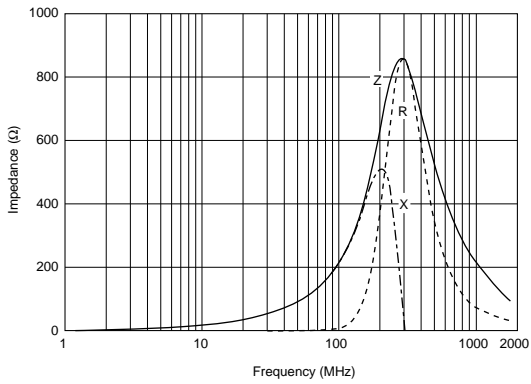

BLM21BD221SN1

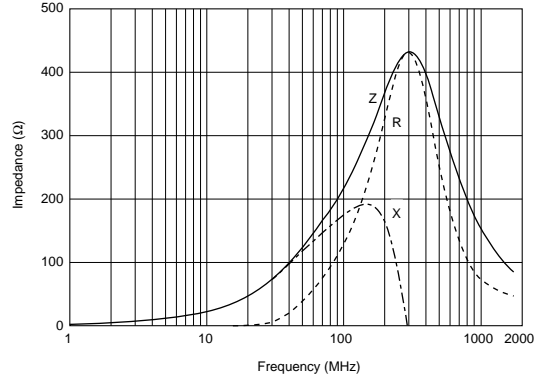

BLM21BB331SN1

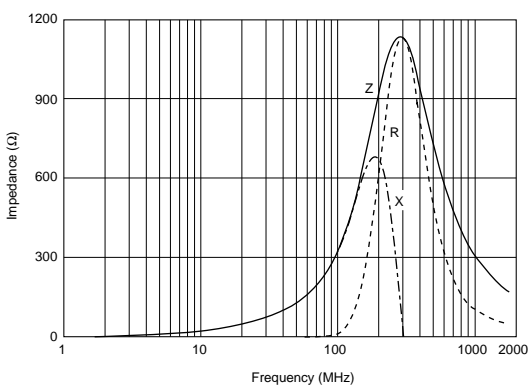

BLM21BD331SN1

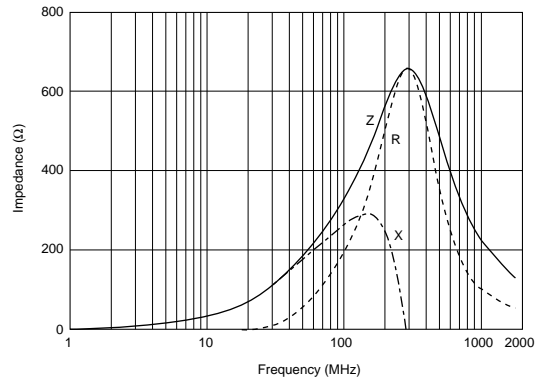

BLM21BD421SN1

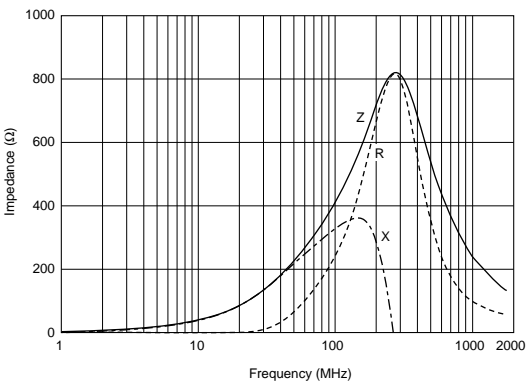

BLM21BB471SN1

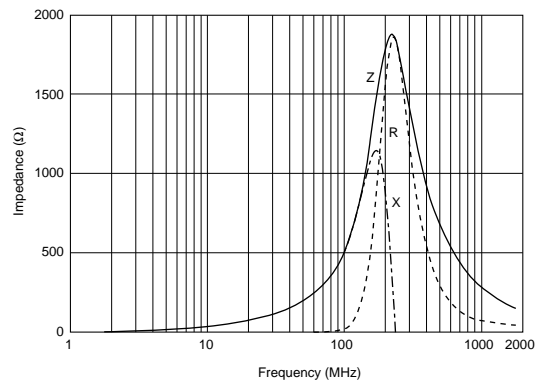

BLM21BD471SN1

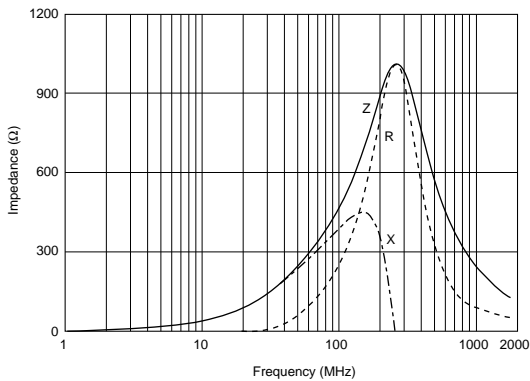

BLM21BD601SN1

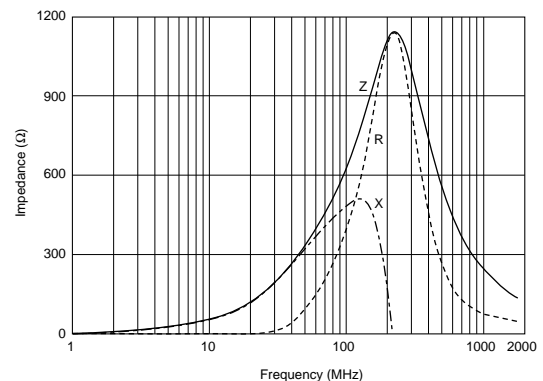

Continued on the following page. ↗

Continued from the preceding page.

Impedance-Frequency Characteristics

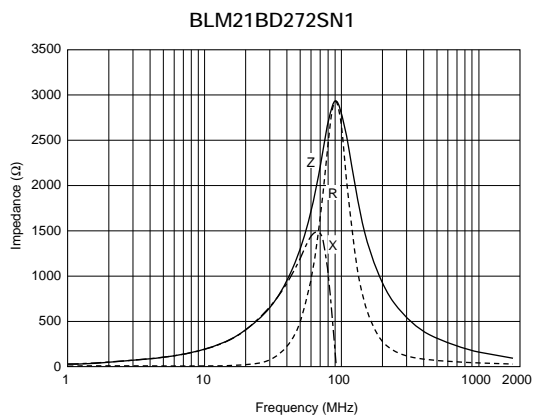
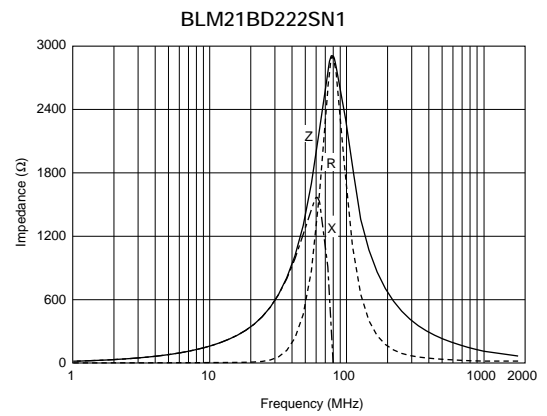
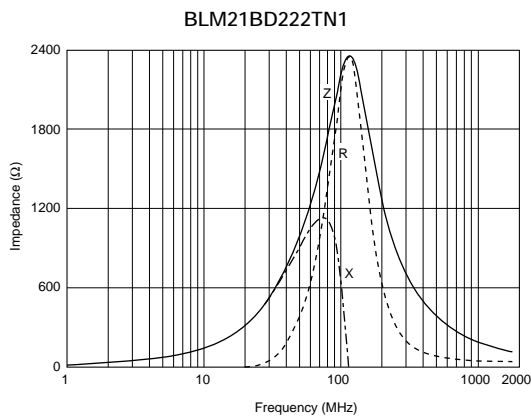
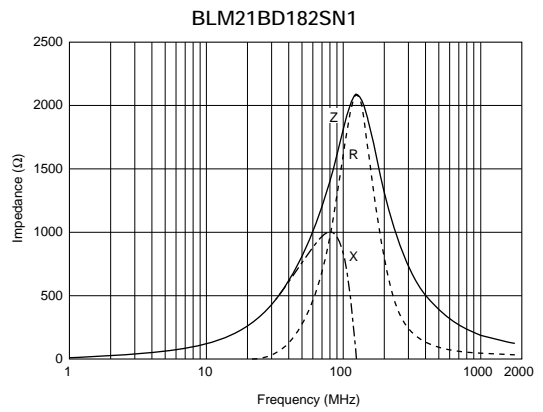
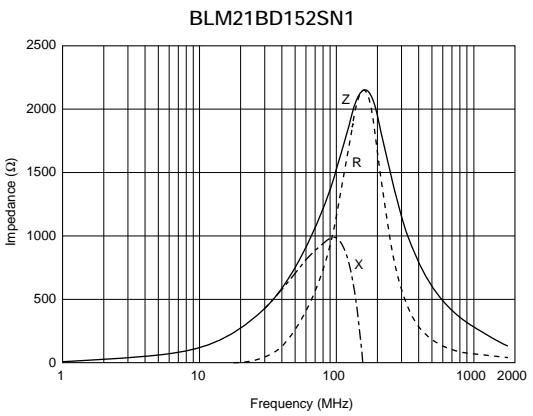
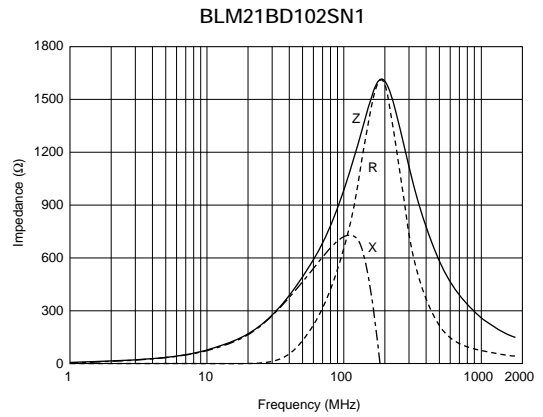
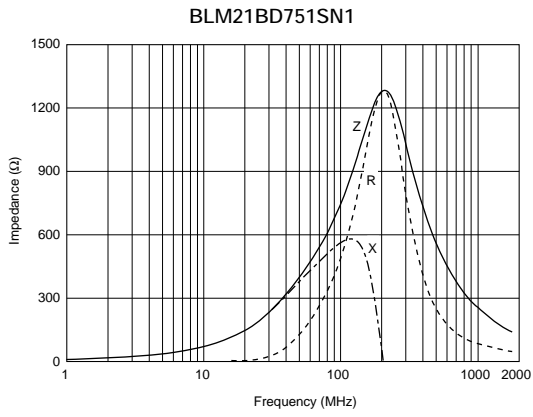

1

BLM31B Series (1206 Size)

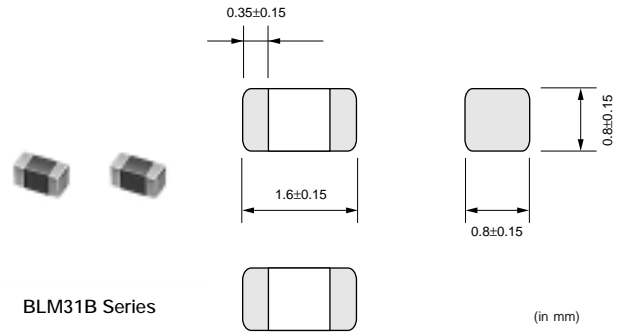

Part Number	Impedance (at 100MHz, 20 degree C) (ohm)	Rated Current (mA)	DC Resistance (max.) (ohm)	Operating Temperature Range (°C)
BLM31BE601FN1	600 ±25%	300	0.35	-55 to +125

■ Impedance-Frequency (Typical)

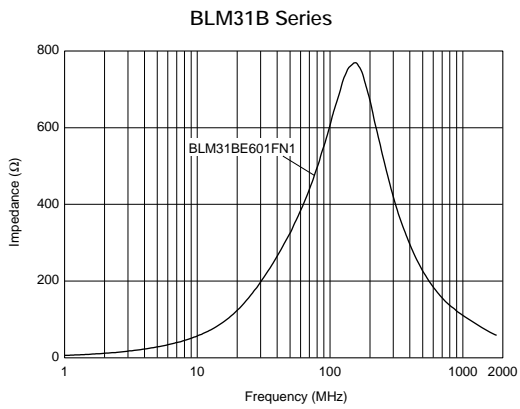

■ Impedance-Frequency Characteristics

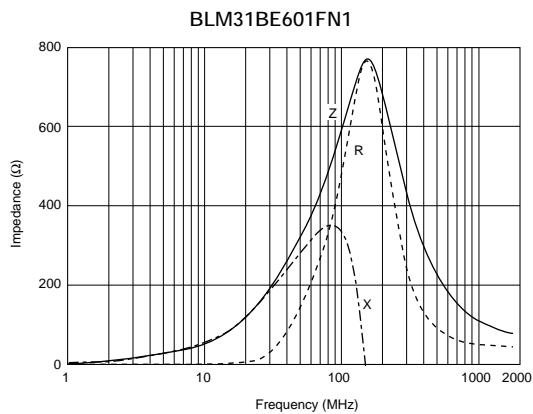

1

■ Features (BLM_R Series)

The chip ferrite beads BLM series comprises ferrite bead in the shape of a chip. This ferrite bead generates a high impedance which at high frequencies mainly consists of a resistance element. The BLM series is effective in circuits without stable ground lines because the BLM series does not need a connection to ground.

The nickel barrier structure of the external electrodes provides excellent solder heat resistance. The BLM_R series can be used in a digital Interface. Resistance of BLM_R series especially grows in the lower frequency range. Therefore BLM_R series is less effective for digital signal waveform at low frequency range and can suppress the ringing.

■ Equivalent Circuit

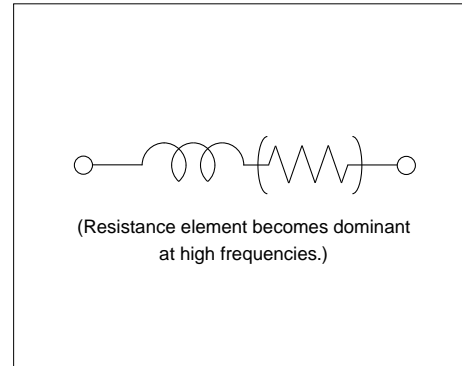

BLM18R Series (0603 Size)

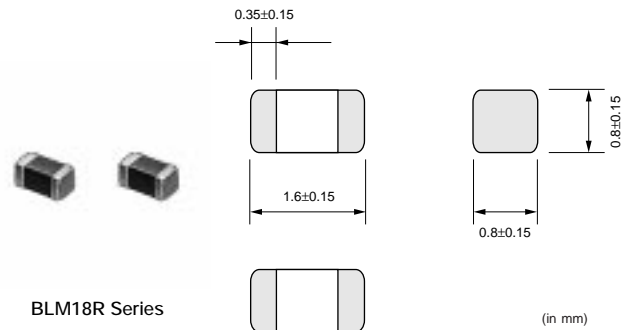

Part Number	Impedance (at 100MHz, 20 degree C) (ohm)	Rated Current (mA)	DC Resistance (max.) (ohm)	Operating Temperature Range (°C)
BLM18RK121SN1	120 ±25%	200	0.25	-55 to +125
BLM18RK221SN1	220 ±25%	200	0.30	-55 to +125
BLM18RK471SN1	470 ±25%	200	0.50	-55 to +125
BLM18RK601SN1	600 ±25%	200	0.60	-55 to +125
BLM18RK102SN1	1000 ±25%	200	0.80	-55 to +125

■ Impedance-Frequency (Typical)

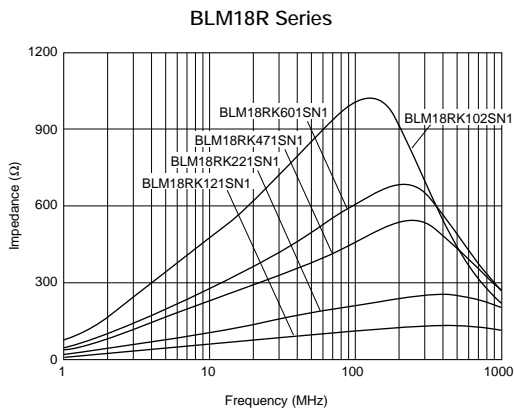

■ Impedance-Frequency Characteristics

BLM18RK121SN1

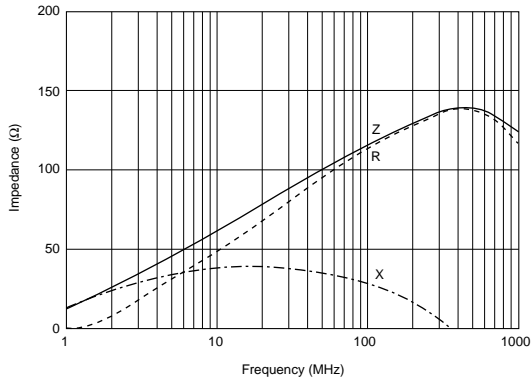

BLM18RK221SN1

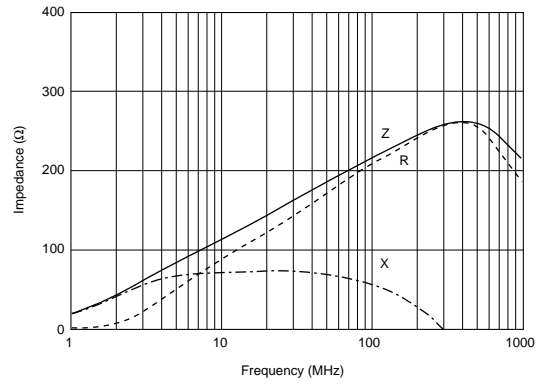

BLM18RK471SN1

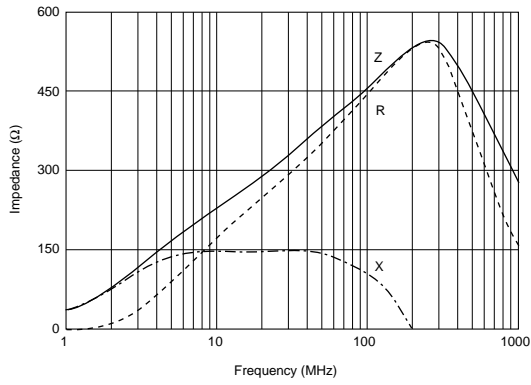

BLM18RK601SN1

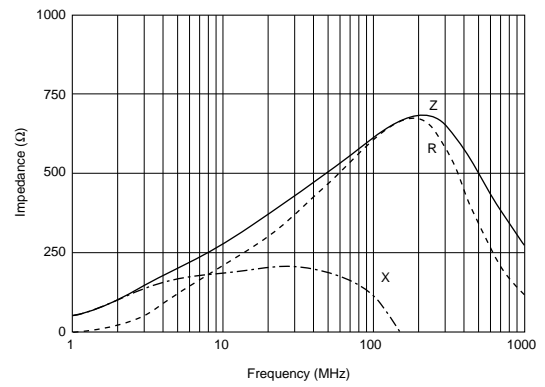

BLM18RK102SN1

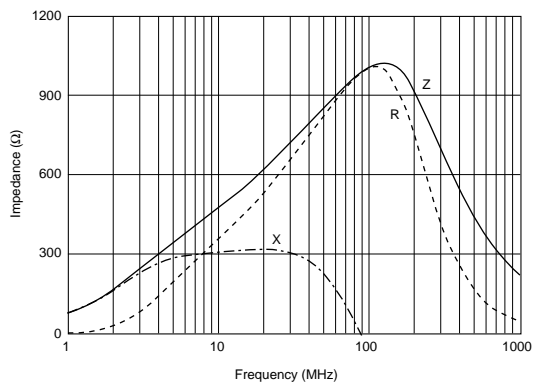

1

BLM21R Series (0805 Size)

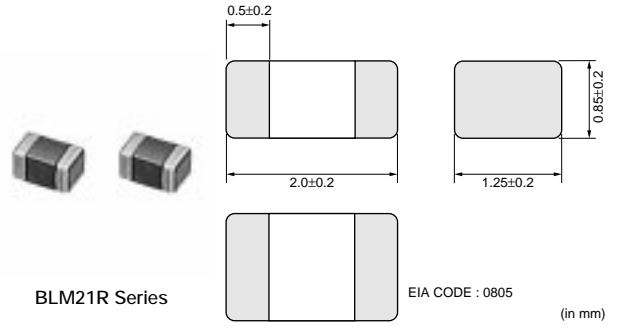

Part Number	Impedance (at 100MHz, 20 degree C) (ohm)	Rated Current (mA)	DC Resistance (max.) (ohm)	Operating Temperature Range (°C)
BLM21RK121SN1	120 ±25%	200	0.15	-55 to +125
BLM21RK221SN1	220 ±25%	200	0.20	-55 to +125
BLM21RK471SN1	470 ±25%	200	0.25	-55 to +125
BLM21RK601SN1	600 ±25%	200	0.30	-55 to +125
BLM21RK102SN1	1000 ±25%	200	0.50	-55 to +125

■ Impedance-Frequency (Typical)

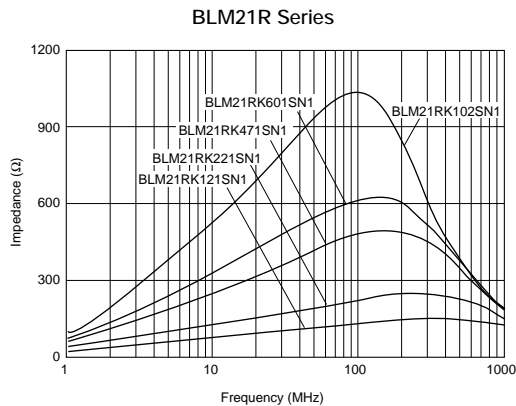

■ Impedance-Frequency Characteristics

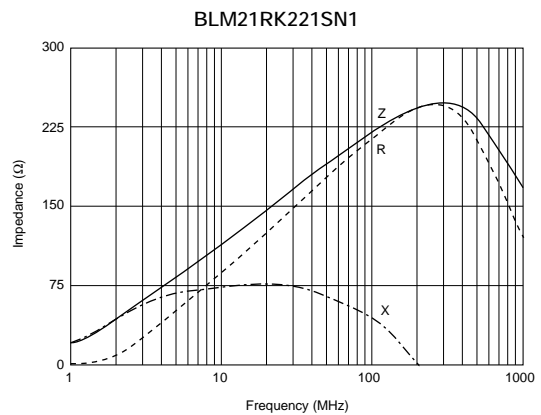
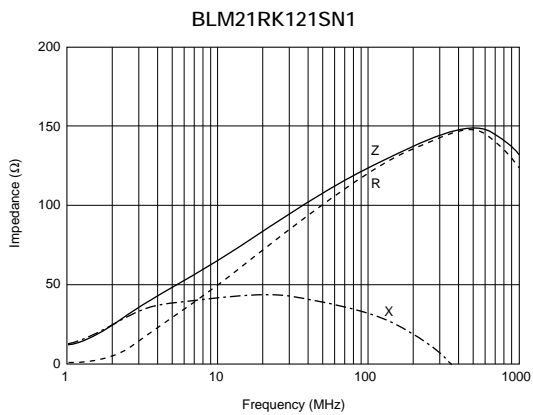

Continued on the following page.

↳ Continued from the preceding page.

■ Impedance-Frequency Characteristics

BLM21RK471SN1

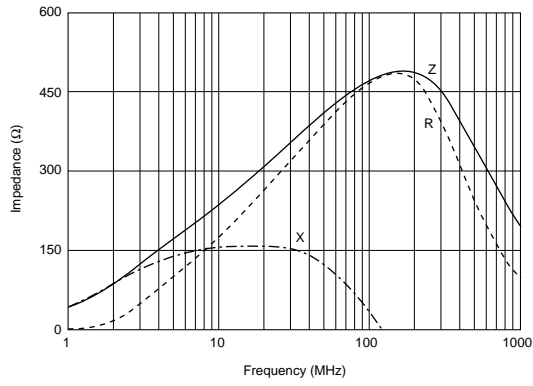

BLM21RK601SN1

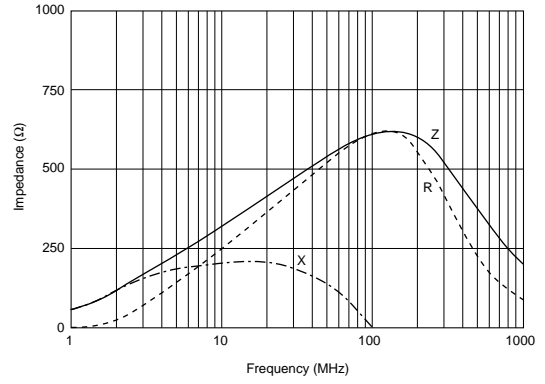

BLM21RK102SN1

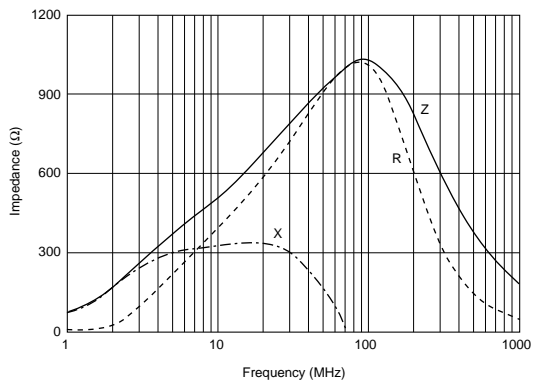

1

1

■ Features (BLM_P Series)

The chip ferrite beads BLM series comprises ferrite bead in the shape of a chip. This ferrite bead generates a high impedance which at high frequencies mainly consists of a resistance element. The BLM series is effective in circuits without stable ground lines because the BLM series does not need a connection to ground.

The nickel barrier structure of the external electrodes provides excellent solder heat resistance. The BLM_P series can be used in high current circuits due to its low DC resistance. It can match power lines to a maximum of 6A DC (BLM41P).

■ Equivalent Circuit

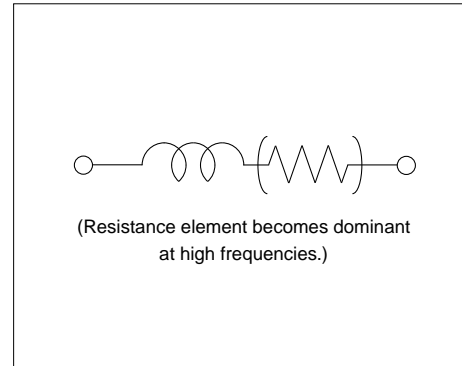

BLM15P Series (0402 Size)

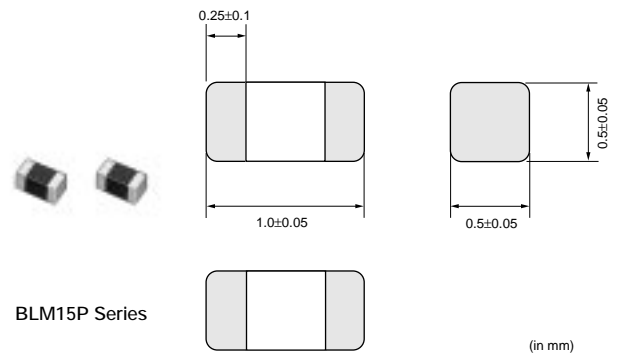

Part Number	Impedance (at 100MHz, 20 degree C) (ohm)	Rated Current (mA)	DC Resistance (max.) (ohm)	Operating Temperature Range (°C)
BLM15PG100SN1	10 (Typ.)	1000	0.05	-55 to +125

■ Impedance-Frequency Characteristics

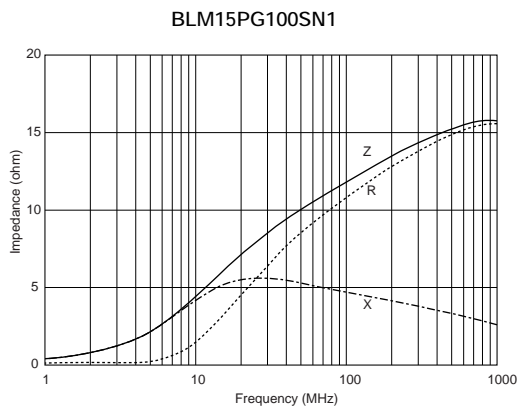

BLM18P Series (0603 Size)

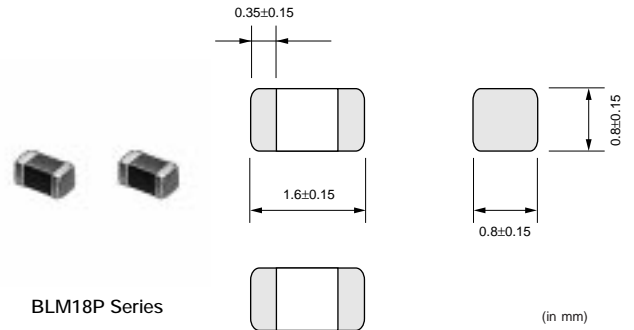

1

Part Number	Impedance (at 100MHz, 20 degree C) (ohm)	Rated Current (mA)	DC Resistance (max.) (ohm)	Operating Temperature Range (°C)
BLM18PG300SN1	30 (Typ.)	1000	0.05	-55 to +125
BLM18PG330SN1	33 ±25%	3000	0.025	-55 to +125
BLM18PG600SN1	60 (Typ.)	500	0.10	-55 to +125
BLM18PG121SN1	120 ±25%	2000	0.05	-55 to +125
BLM18PG181SN1	180 ±25%	1500	0.09	-55 to +125

At rated current upper than 1500mA, derating is required.
Please refer P. 53, "Derating of Rated Current".

■ Impedance-Frequency (Typical)

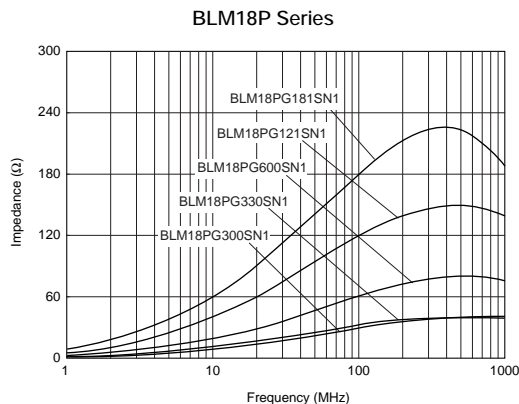

■ Impedance-Frequency Characteristics

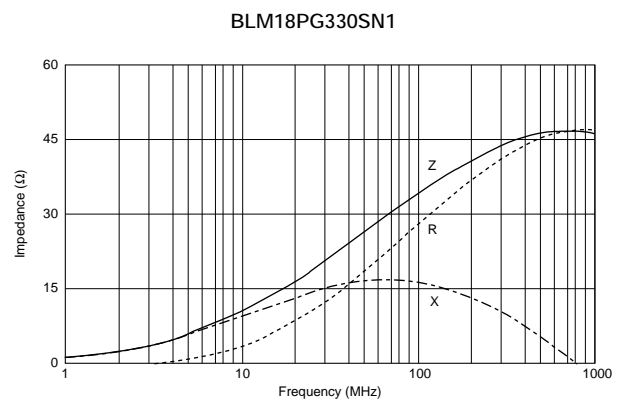
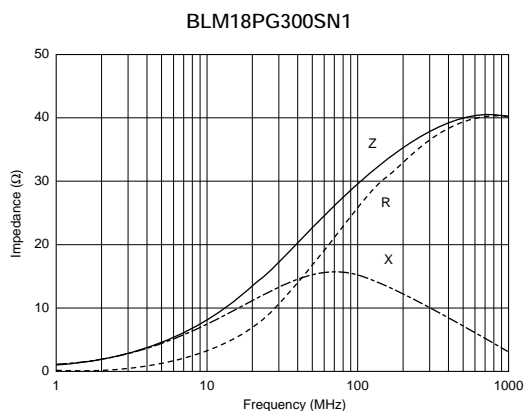

Continued on the following page. ↗

Continued from the preceding page.

Impedance-Frequency Characteristics

BLM18PG600SN1

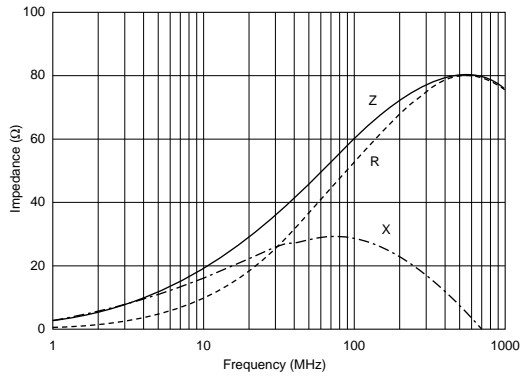

BLM18PG121SN1

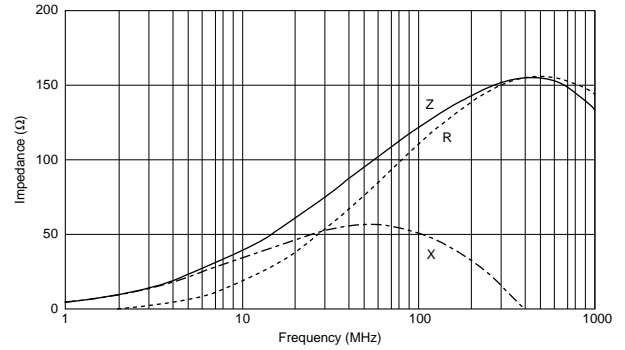

BLM18PG181SN1

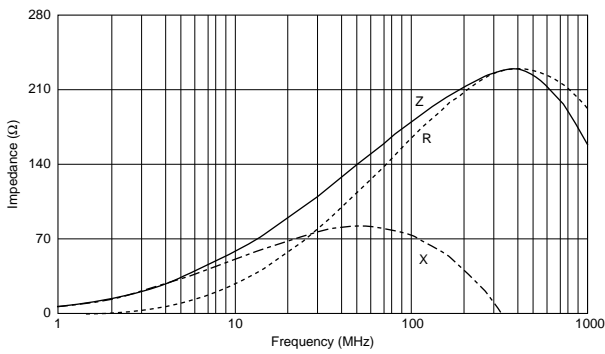

BLM21P Series (0805 Size)

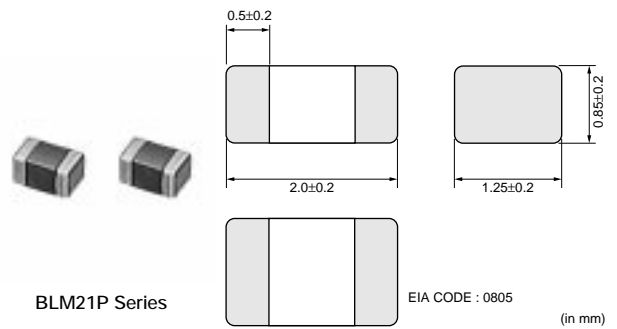

Part Number	Impedance (at 100MHz, 20 degree C) (ohm)	Rated Current (mA)	DC Resistance (max.) (ohm)	Operating Temperature Range (°C)
BLM21PG220SN1	22 ±25%	6000	0.01	-55 to +125
BLM21PG300SN1	30 (Typ.)	3000	0.015	-55 to +125
BLM21PG600SN1	60 ±25%	3000	0.025	-55 to +125
BLM21PG221SN1	220 ±25%	2000	0.050	-55 to +125
BLM21PG331SN1	330 ±25%	1500	0.09	-55 to +125

At rated current upper than 1500mA, derating is required.
Please refer P. 53, "Derating of Rated Current".

■ Impedance-Frequency (Typical)

BLM21P Series

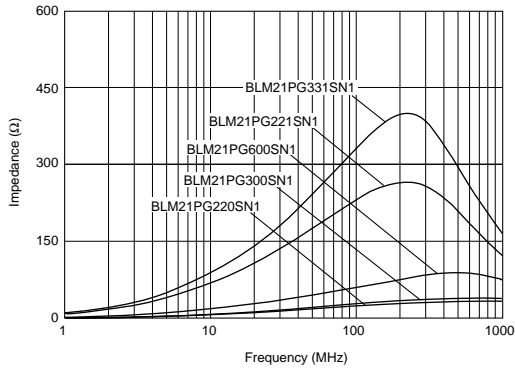

■ Impedance-Frequency Characteristics

BLM21PG220SN1

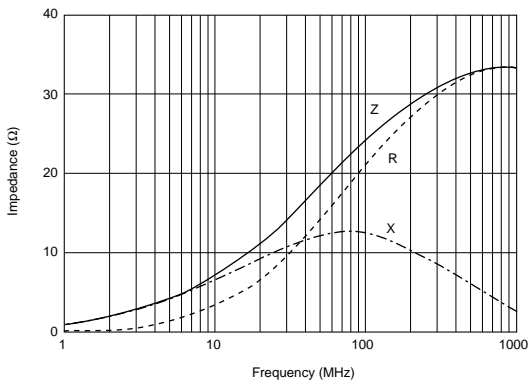

BLM21PG300SN1

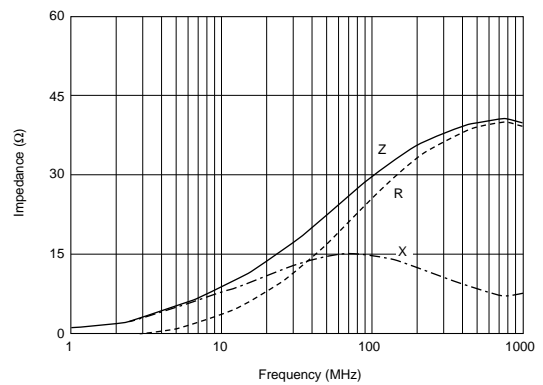

BLM21PG600SN1

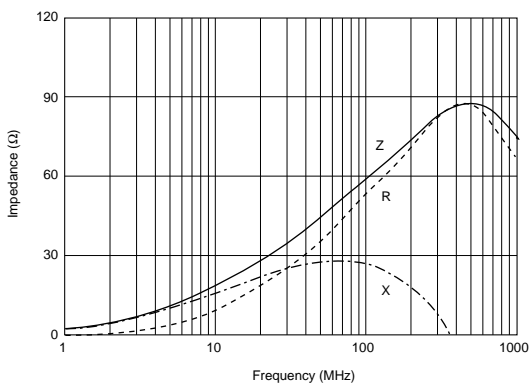

BLM21PG221SN1

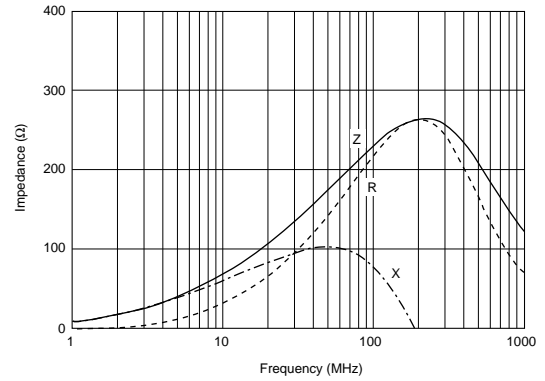

BLM21PG331SN1

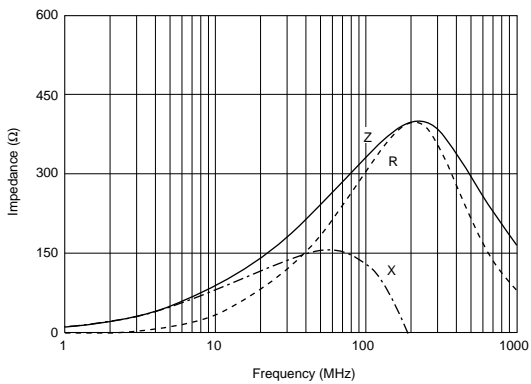

BLM31P Series (1206 Size)

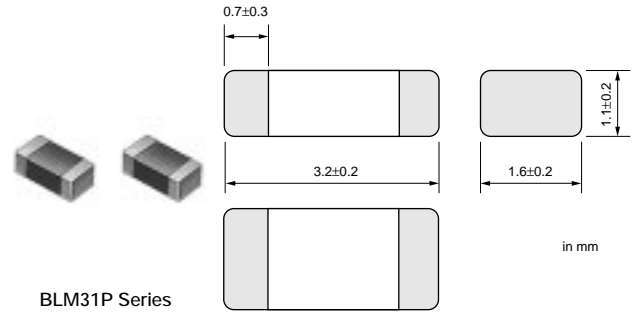

BLM31P Series

Part Number	Impedance (at 100MHz, 20 degree C) (ohm)	Rated Current (mA)	DC Resistance (max.) (ohm)	Operating Temperature Range (°C)
BLM31PG330SN1	33 ±25%	6000	0.01	-55 to +125
BLM31PG500SN1	50 (Typ.)	3000	0.025	-55 to +125
BLM31PG121SN1	120 ±25%	3000	0.025	-55 to +125
BLM31PG391SN1	390 ±25%	2000	0.05	-55 to +125
BLM31PG601SN1	600 ±25%	1500	0.09	-55 to +125

At rated current upper than 1500mA, derating is required.
Please refer P. 53, "Derating of Rated Current".

■ Impedance-Frequency (Typical)

BLM31P Series

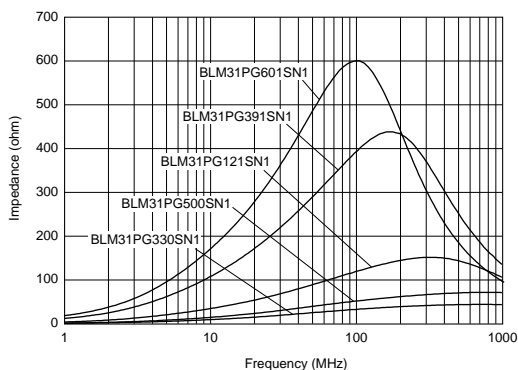

■ Impedance-Frequency Characteristics

BLM31PG330SN1

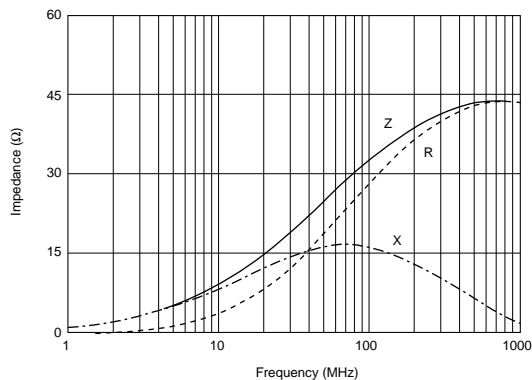

BLM31PG500SN1

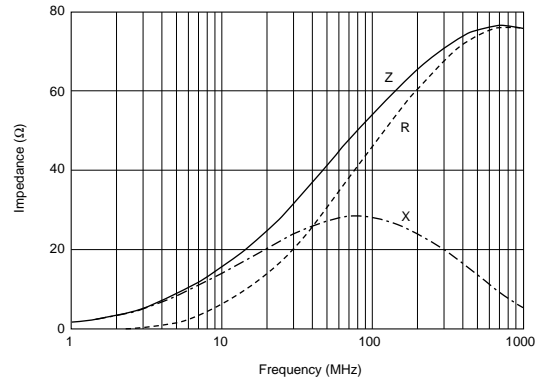

Continued on the following page. ↗

Continued from the preceding page.

Impedance-Frequency Characteristics

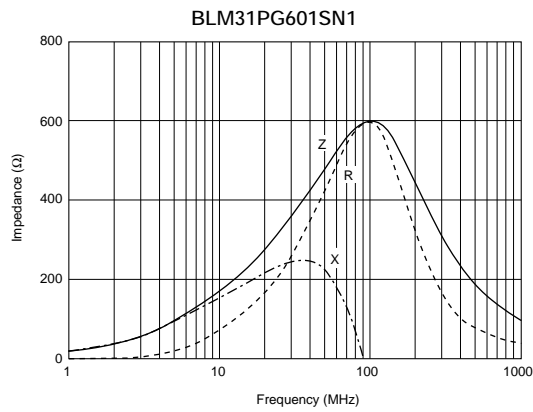
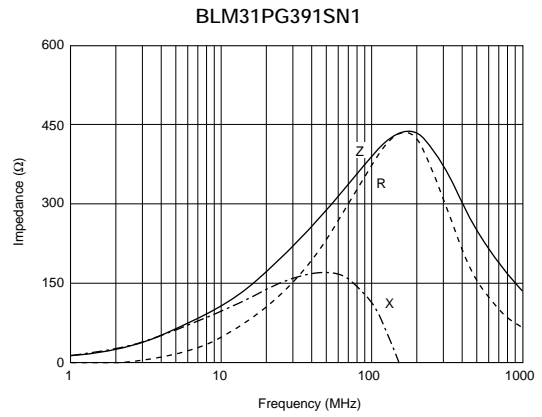
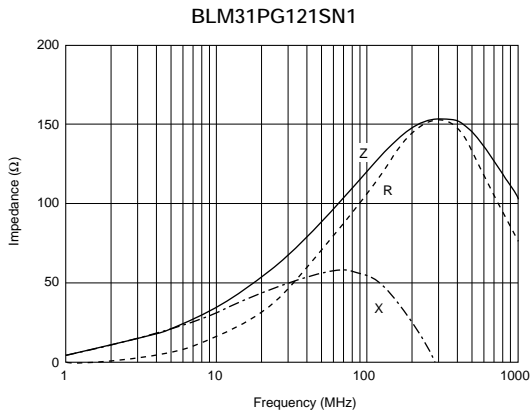

BLM41P Series (1806 Size)

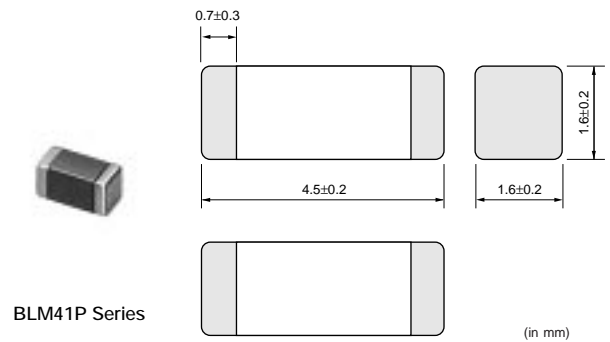

Part Number	Impedance (at 100MHz, 20 degree C) (ohm)	Rated Current (mA)	DC Resistance (max.) (ohm)	Operating Temperature Range (°C)
BLM41PG600SN1	60 (Typ.)	6000	0.01	-55 to +125
BLM41PG750SN1	75 (Typ.)	3000	0.025	-55 to +125
BLM41PF800SN1	80 (Typ.)	1000	0.10	-55 to +125
BLM41PG181SN1	180 ±25%	3000	0.025	-55 to +125
BLM41PG471SN1	470 ±25%	2000	0.05	-55 to +125
BLM41PG102SN1	1000 ±25%	1500	0.09	-55 to +125

At rated current upper than 1500mA, derating is required.
Please refer P. 53, "Derating of Rated Current".

■ Impedance-Frequency (Typical)

BLM41P Series (80-180ohm)

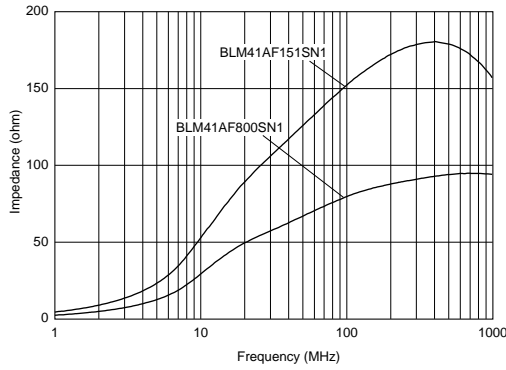

BLM41P Series (470-1000ohm)

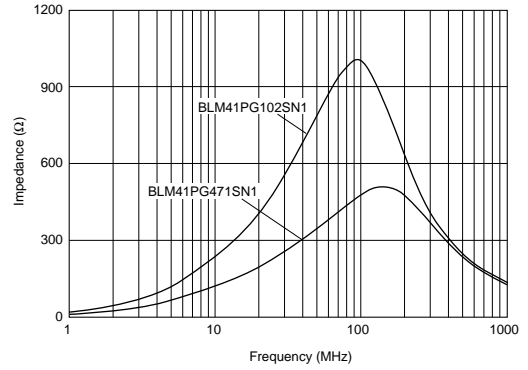

■ Impedance-Frequency Characteristics

BLM41PG600SN1

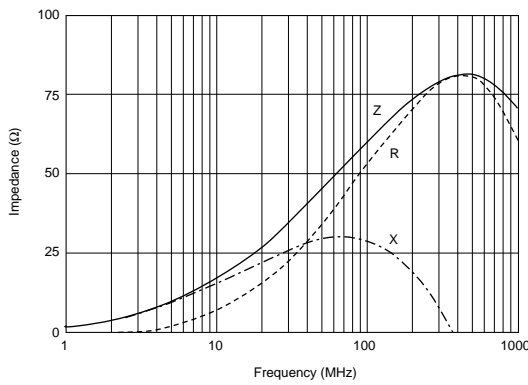

BLM41PG750SN1

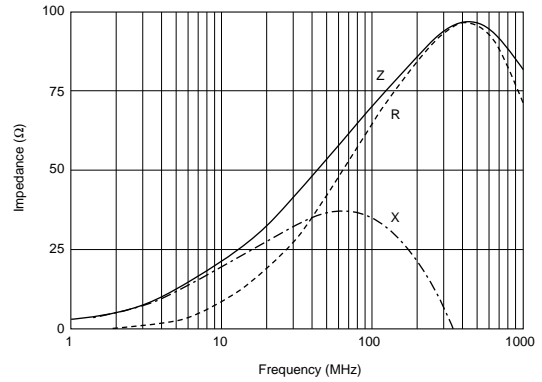

BLM41PF800SN1

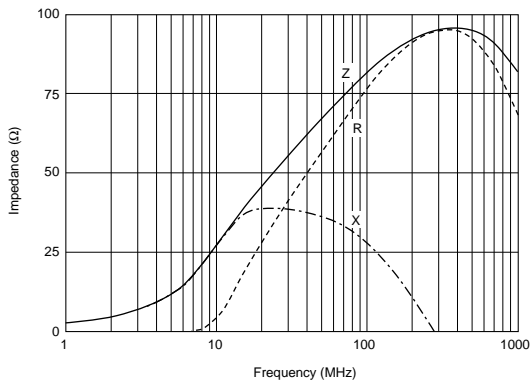

BLM41PG181SN1

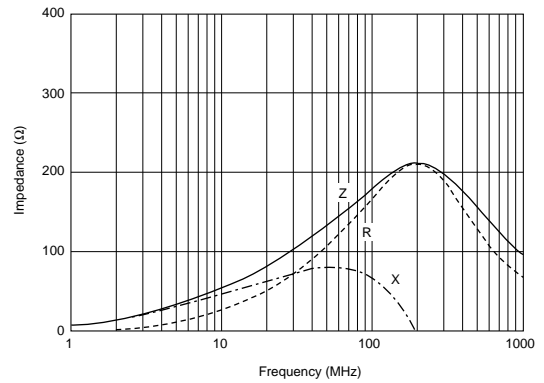

BLM41PG471SN1

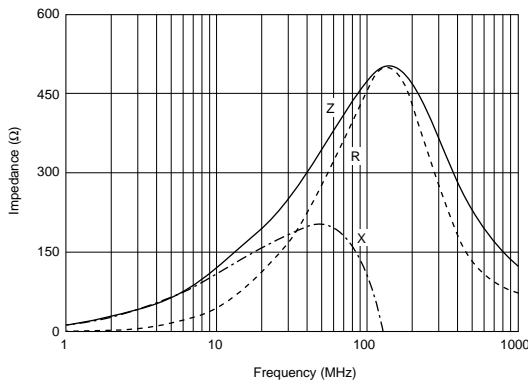

BLM41PG102SN1

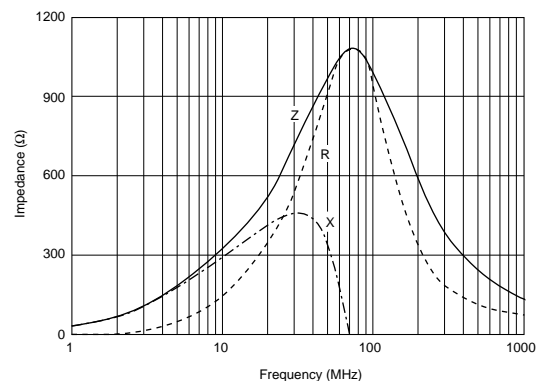

Continued on the following page. ↗

☐ Continued from the preceding page.

■ Notice (Rating)

In operating temperatures exceeding +85°C, derating of current is necessary for chip Ferrite Beads for which rated current is 1.5A or over. Please apply the derating curve shown below according to the operating temperature.

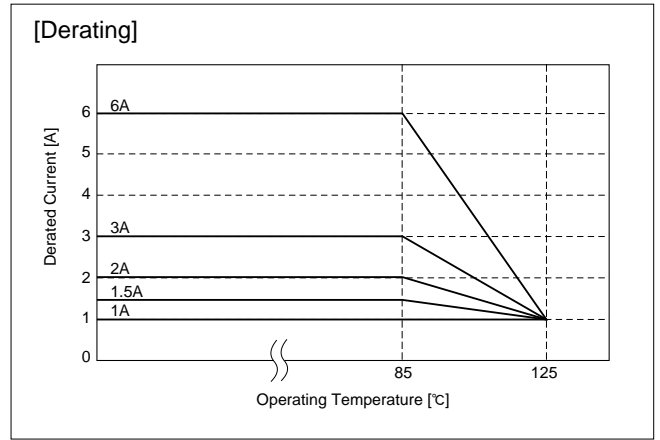

1